

PanoMeasure2 (Standard Edition) Operating Manual

For version 1.38

3rd of June 2020

Zoomscape Inc.

All Rights Reserved

About PanoMeasure2

PanoMeasure2 software enables users to quickly and easily create 3-D drawings and obtain measurements from 360° photographs taken with the Ricoh Theta. Shadows, expansion, shrinkage, and other visual effects aid users' intuitive mouse and touch-panel use.

This standard version uses panoramic images taken from a single viewpoint, to enable simple configuration measurements. We recommend testing out the temporary license demonstration version before making a purchase.

Table of Contents

Operator's manual for the Standard Edition PanoMeasure2 (Standard Edition) Operating Manual	1
1. Use	4
1.1. Operating Environments	4
1.1.1. Supported Computers	4
1.1.2. Image Compatibility	4
1.2. Installing a Standard PanoMeasure2	4
1.2.1. Purchasing and Downloading This Software	4
1.2.2. Installation Procedures	4
1.2.2.1. Installation File Message	4
1.2.2.2. Language Selection	5
1.2.2.3. Licensing Agreement	5
1.2.2.4. Selecting Components and Specifying Program Saving Folders	5
1.2.2.5. Selecting a Start Menu Folder and Installing the Program	6
1.2.3. Provisional and Official Licenses	6
1.3. Software Updates	7
2. Fundamental Operations	7
2.1. Selecting Panoramic Images	7
2.2. Moving an Image (altering your viewpoint)	8
2.3. Changing the Display Magnification (zooming in and out)	9
2.4. Moving the VTM (Virtual Tape Measure) Horizontally	9
2.5. Moving the VTM Vertically	10
2.6. Moving the VTM in the Depth Direction	11
2.7. Expanding and Rotating the VTM	12
2.8. Measuring Dimensions	12
2.9. Rebooting the VTM	14
2.10. Rendered Images: Drawing 1: Drawing from Measured Points	14
2.11. Rendered Images: Drawing 2: Connecting Points	16
2.12. Displaying 3-D Drawings with Measured Lines	16
3. Changing Images	17
3.1. How to Open a Saved Panorama Image	17
3.2. Loading Images taken with a Ricoh Theta	19
3.3. Adjusting Ricoh Theta Image Levels	22
3.4. Adjusting Camera Height	27
4. Editing Points and Lines	29
4.1. Selecting Points for Measurement	29
4.2. Editing Points	30
4.3. Selecting Lines	31

4.4.	Deleting Selected Points or Lines	32
5.	Using the VTM (Virtual Tape Measure)	33
5.1.	Moving the VTM.....	33
5.2.	Other Ways of Moving the VTM.....	34
5.3.	Aligning the Axis Parallel to Previously Measured Lines	35
5.4.	Setting the VTM for a Distance Between Two Points	35
5.5.	Making Use of the Orthogonality of the Axes to Draw Objects and Spaces	37
5.6.	Drawing by Inputting Known Dimensions.....	37
5.7.	Adjusting Depth Using Known Dimensions.....	38
6.	Converting Coordinates and Assembling Drawings	39
6.1.	Dividing a space into Blocks and Producing Block Drawings	39
6.2.	The Need for Coordinate Conversion.....	39
6.3.	How to Convert Coordinates	40
6.3.1.	Specifying Origin Coordinates.....	41
6.3.1.1.	Using Coordinates to Unify Axis Arrow Direction.....	41
6.3.1.2.	Rotating the Coordinate Axis. (the X axis is green, and the Y, yellow).....	41
6.3.1.3.	Moving the VTM to the Reference Point.....	42
6.3.1.4.	Inputting Reference Point Coordinates.....	42
6.3.1.5.	Clicking on “Convert.”	42
6.3.1.6.	Clicking on “Undo Coordinate Conversion” to Try Again	43
6.3.2.	Using the Clipboard to Specify the Reference Point Coordinates.....	43
6.4.	Loading the Drawing Data After Coordinate Conversion.....	45
6.5.	Moving the Vantage Point	47
7.	Other Functions.....	48
7.1.	Saving Data under a New Name, and Loading, Deleting and Recovering Data.....	48
7.2.	Exporting Data	48
7.3.	License Information	49
7.4.	GPU Information.....	49
7.5.	Software Information.....	50
7.6.	Confirming Newest Software Version Updates.....	50
8.	Tool menu.....	50
8.1.	Changing the Display Language.....	50
8.2.	Brightness Control.....	51
8.3.	Switching to Full Screen.....	51
8.4.	Changing the Window Size.....	51
8.5.	Settings (Changing Units of Length, Adjusting the Maximum Viewing Angle)	51
9.	Operating Requirements.....	52

1. Use

1.1. Operating Environments

1.1.1. Supported Computers

PanoMeasure2 operates with Microsoft Windows desktop environments. We recommend Windows 7, 8, 8.1, and 10. We have also confirmed operation on Vista. Graphic boards, graphic chips, Open GL 2.1 or more recent versions, are required for operation. This software may not be operational on old computers. For details see Chapter 9 “Operating Requirements.”

This software is not operational on Macintosh, iOS, or Android smartphones or tablets. It is operational on Windows tablets, but we do not recommend tablet mode use.

1.1.2. Image Compatibility

Omnidirectional (spherical panorama) images taken with a Ricoh Theta camera are compatible with this software. However, they cannot be directly loaded into the software. It is first necessary to use the Theta Cube to convert your omnidirectional Theta image to a “cubic panorama” image. This is explained in chapter 3.2, “Loading a Ricoh Theta Image.”

This software is also compatible with panorama images taken with (a) normal wide-angle lens PTGui or Hugin, images taken with a normal camera equipped with a fish eye lens or (c) panorama images assembled into an omnidirectional image with panoramic support from a PTGui or Hugin. All of the above images must also be converted to “cubic panorama” data format before they can be manipulated with the PanoMeasure2.

1.2. Installing a Standard PanoMeasure2

1.2.1. Purchasing and Downloading This Software

The PanoMeasure2 standard version software is available at

(<http://www.zoomscape.net/panomeasure/>) For purchasing and downloading information, see our website. This manual is written with the assumption that you have already downloaded the software.

1.2.2. Installation Procedures

1.2.2.1. Installation File Message

The prompt at right will appear when the installation file opens. Click “Yes (Y)” to continue with installation.

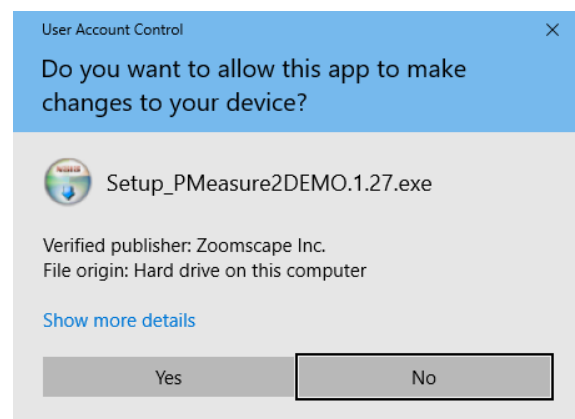

1.2.2.2. Language Selection

You have a choice of Japanese or English language prompts. Select “English” as the installation language. This will make it the default operating language for your Panomeasure2 and for all further installation directions.



1.2.2.3. Licensing Agreement

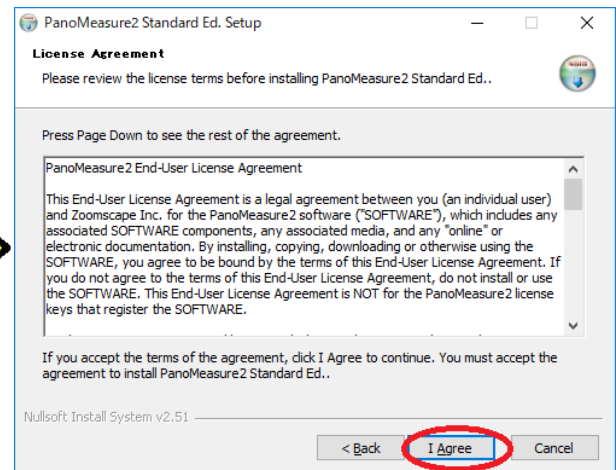
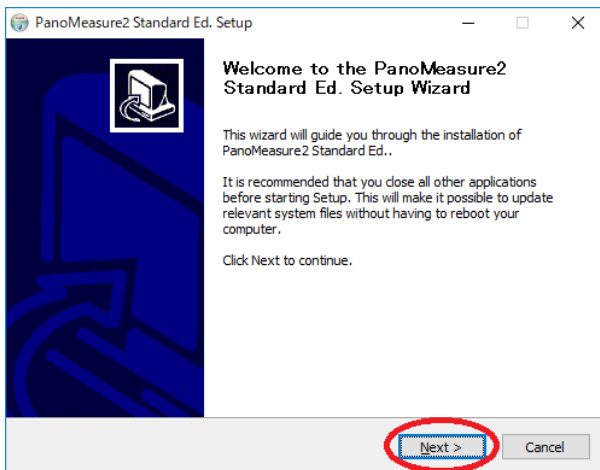

To use this software, you must agree to the terms and conditions of use as laid out in the above right figure. Read the entire agreement and click on agree. After agreeing to these terms and conditions, continue with installation.

1.2.2.4. Selecting Components and Specifying Program Saving Folders

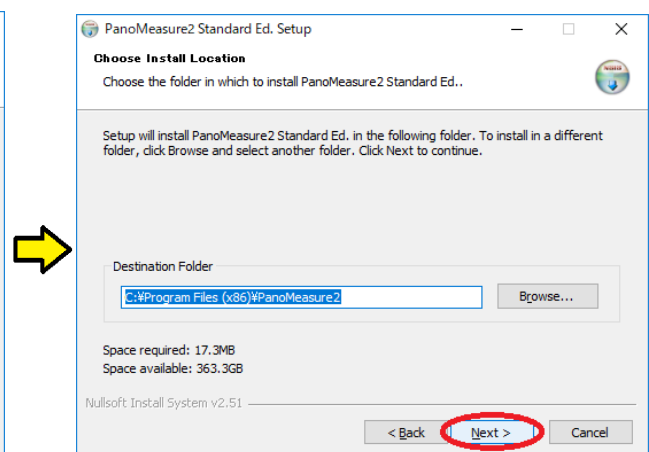
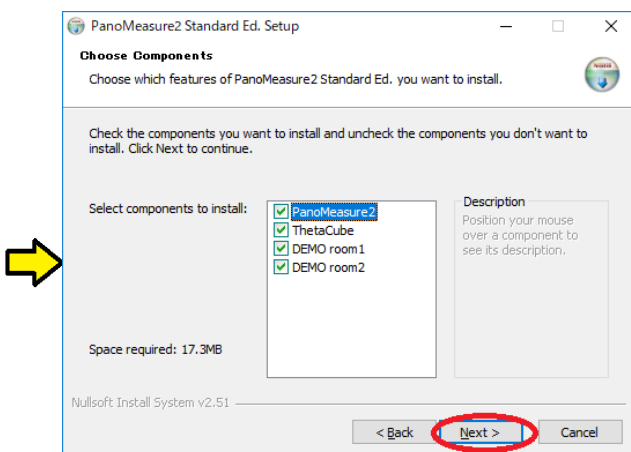

The installer includes a demonstration program. We recommend that first time users install the demonstration images (DEMO room1 and room2) and use them to learn how to use this program. The demonstration images are frequently referred to in this manual. If they are unnecessary, uncheck them and they will not be installed.

It is usually unnecessary to change the program installation folder.

1.2.2.5. Selecting a Start Menu Folder and Installing the Program

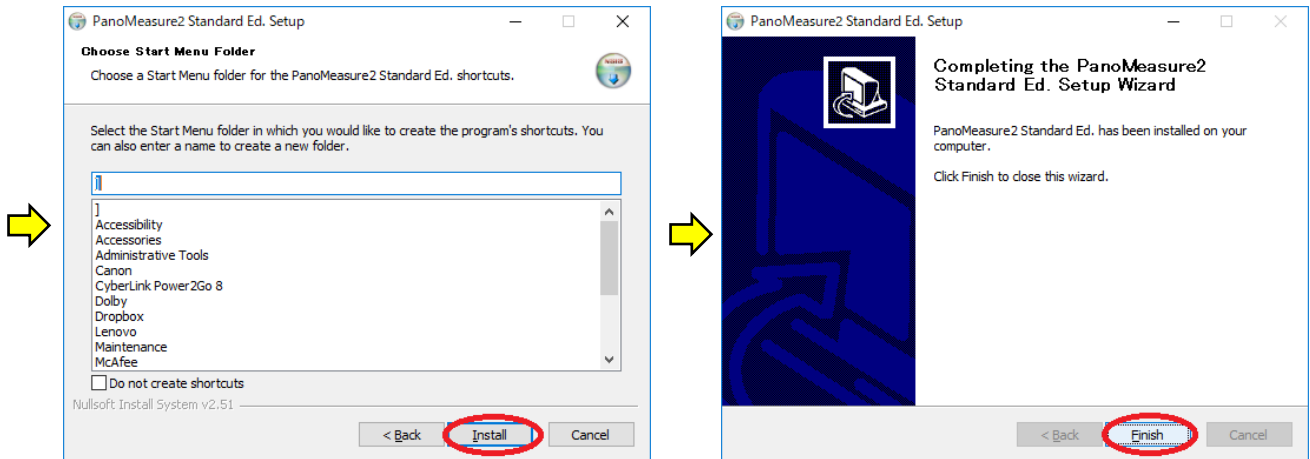

Next, the start menu folder selection window will appear. It is not necessary to change the location. Simply click “install” to begin the installation process. When the above window appears, click “Finished.”

Once the program is installed, the PanoMeasure2 and Theta Cube icons will appear on the desktop. Theta Cube software reformats Ricoh Theta images so they can be used in PanoMeasure2.



1.2.3. Provisional and Official Licenses

The standard edition installer you have downloaded comes bundled with a provisional license. All functions are available with the temporary license. It expires 3 months from the “build” date. So, you will need to obtain a permanent license before it expires. The permanent license can be used indefinitely. When the PanoMeasure2 is activated, the dialog box at right will open. Click on “Request a License” and your web browser will take you to the registration website Panomeasure2 Licensing desk where you can fill in the required fields to request a permanent license. You will receive the permanent license codes by email in a few business days. Enter the serial number and authentication key you receive by email in the fields of the dialog box shown above and click “authenticate” to change to a permanent license.

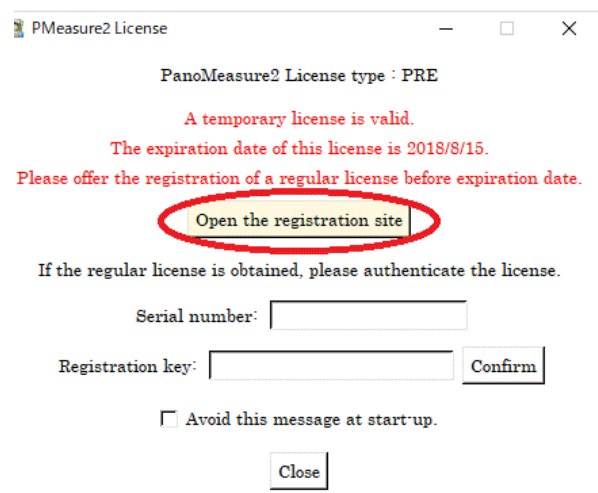

1.3. Software Updates

You will automatically be prompted to update the software when the program loads. If you do not already have the most recent program, a message like the one below will appear. Clicking on “Yes” will activate your Web browser and an installation file with a title such as Update program 1.27 will be downloaded. If you already have the most recent version, no message will appear.

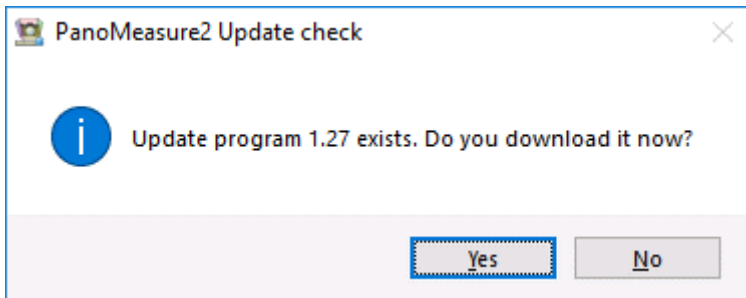

After the update download, close PanoMeasure2 and the update will be installed.

2. Fundamental Operations

2.1. Selecting Panoramic Images

When the program loads, main window will appear.

First, click on the menu of “ Select panorama folder” from the  on the upper left corner of the screen.

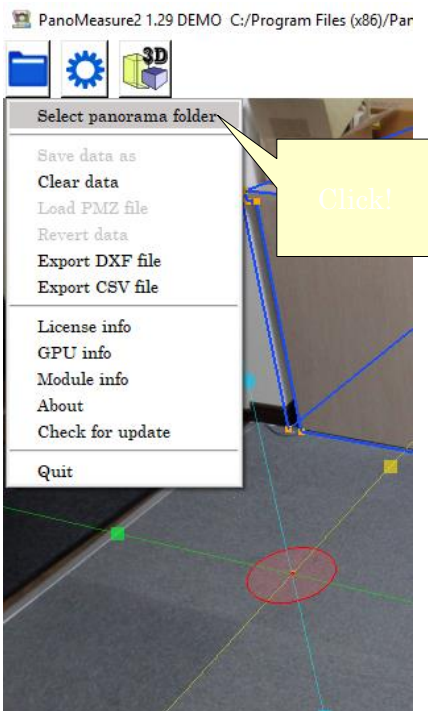

Then, a “Select a panoramic image” window will appear.

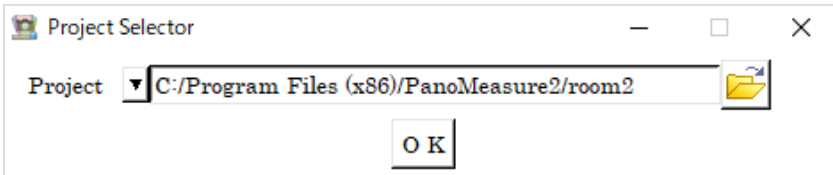

Clicking on  will open the selection windows shown below. Open the folder with the panoramic image you wish to measure and select the image you will work with. Click on Open (O).

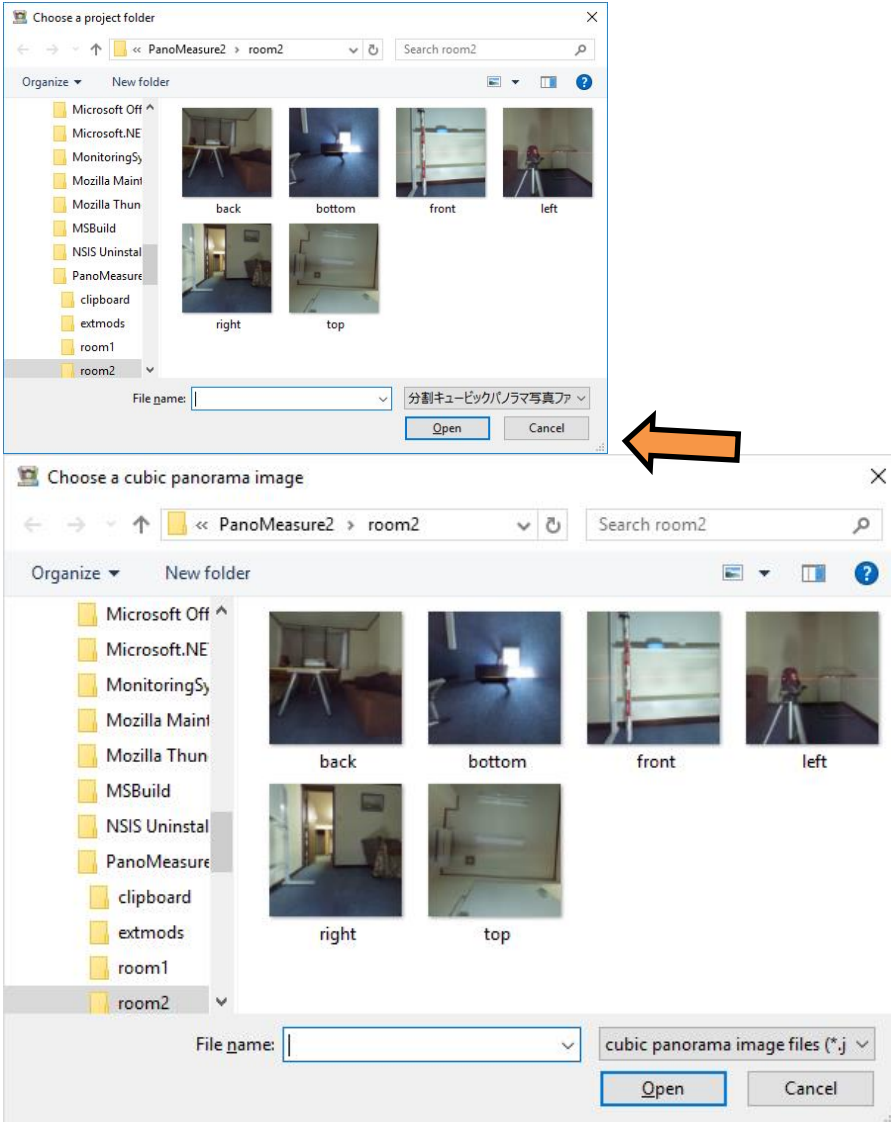

Alternatively, you can click on  and select a panoramic image from your saved image history.

2.2. Moving an Image (altering your viewpoint)

Dragging the image will move it in the direction it is dragged. (Swipe if you are using a tablet.) You can view the image by slowly spinning it in the same way as when using panorama software. You are not actually turning the image. You are changing the direction from which you are viewing the image.

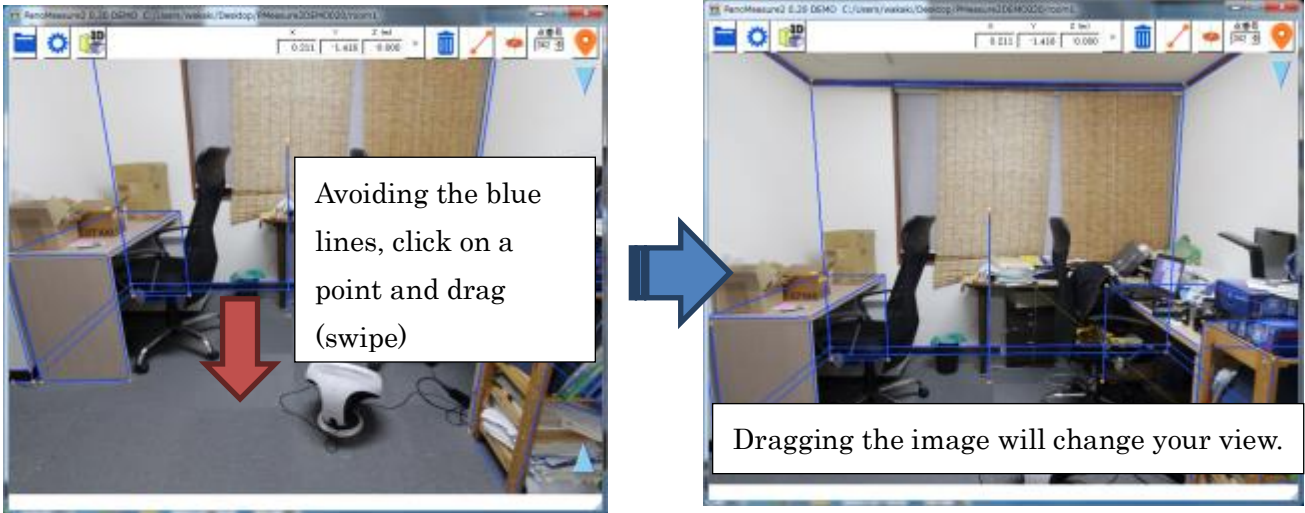

2.3. Changing the Display Magnification (zooming in and out)

Rolling the mouse changes the magnification of the image. On a tablet, pinching in or out will accomplish this.

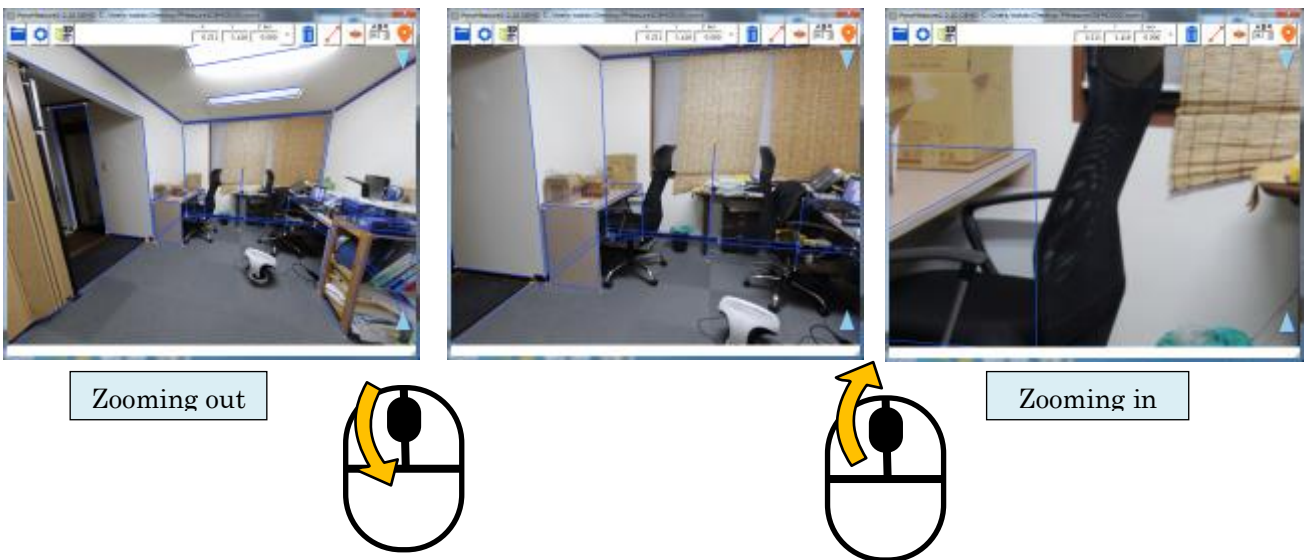

2.4. Moving the VTM (Virtual Tape Measure) Horizontally

To measure the dimensions of a room or the objects in it, or to draw a diagram of a room, you can use a tool called a VTM (Virtual Tape Measure). The VTM consists of three orthogonal axes and a semi-transparent disc. The coordinates for the center of the semi-transparent red disc (referred to as “red disc” below) are visible in the toolbar. Move the VTM three-dimensionally on the screen and by positioning it on the object or part of the room you wish to measure, you can identify the 3-D coordinates of that position.

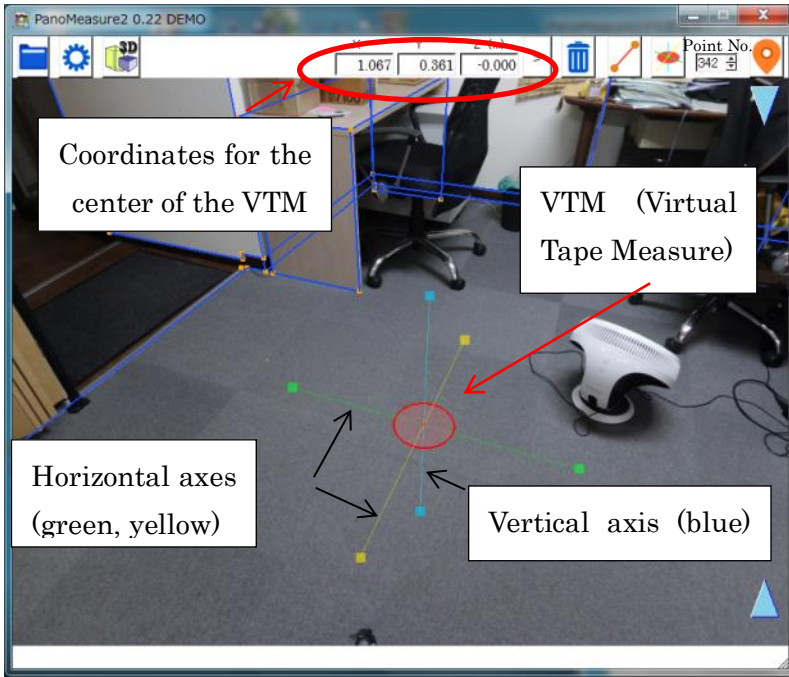

Drag the red disc to move the VTM. When you drag it to the edge of the image, the image will scroll automatically. (You do not need to drag the image to move it when you reach the edge of the image.)

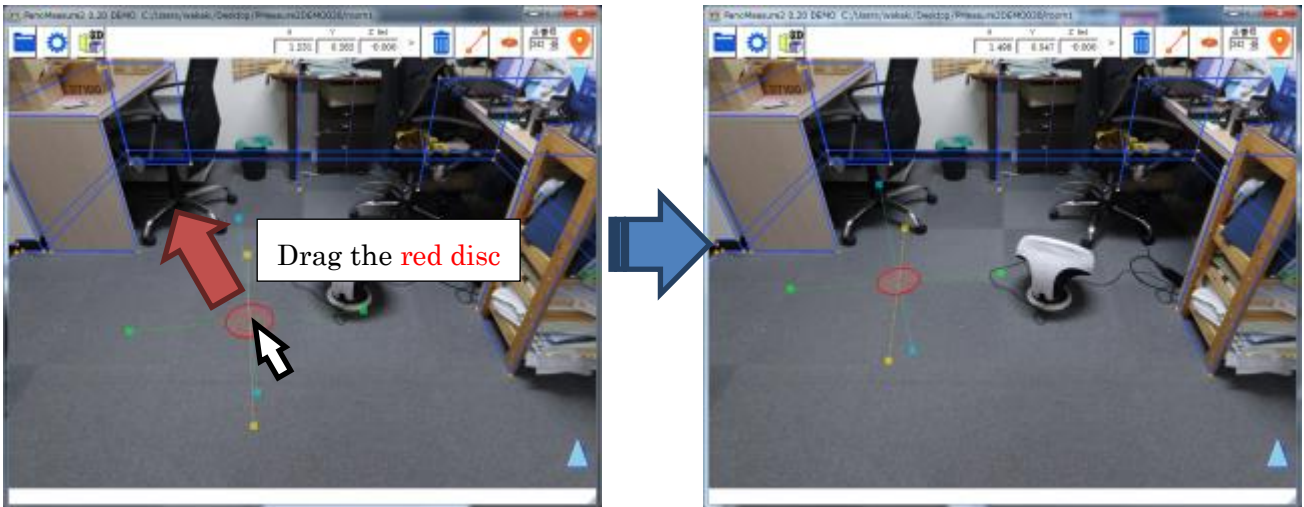

When you drag the red disc the VTM moves through a single horizontal plane. For example, in the figure above, the VTM is on the floor. When the red disc is dragged the VTM moves horizontally along the floor.

2.5. Moving the VTM Vertically

Drag the icon up and the VTM will move up with it.

Drag the icon down and the VTM will move down with it.

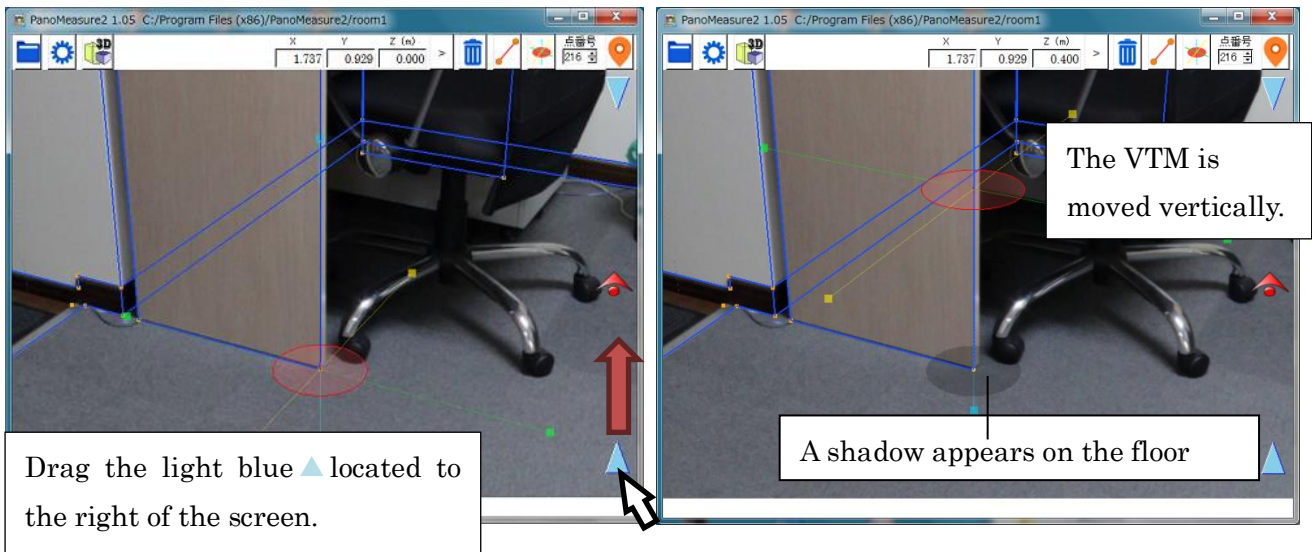

When the VTM is lifted up from the floor it casts a shadow on the floor. The relative position of the red disc to the shadow on the floor will show you how far the VTM is from the floor. By paying attention to the presence or absence of the shadow, you can avoid moving horizontally when you think you are moving vertically.

The disc will appear as a semi-transparent white circle on the floor when you take it below floor level.

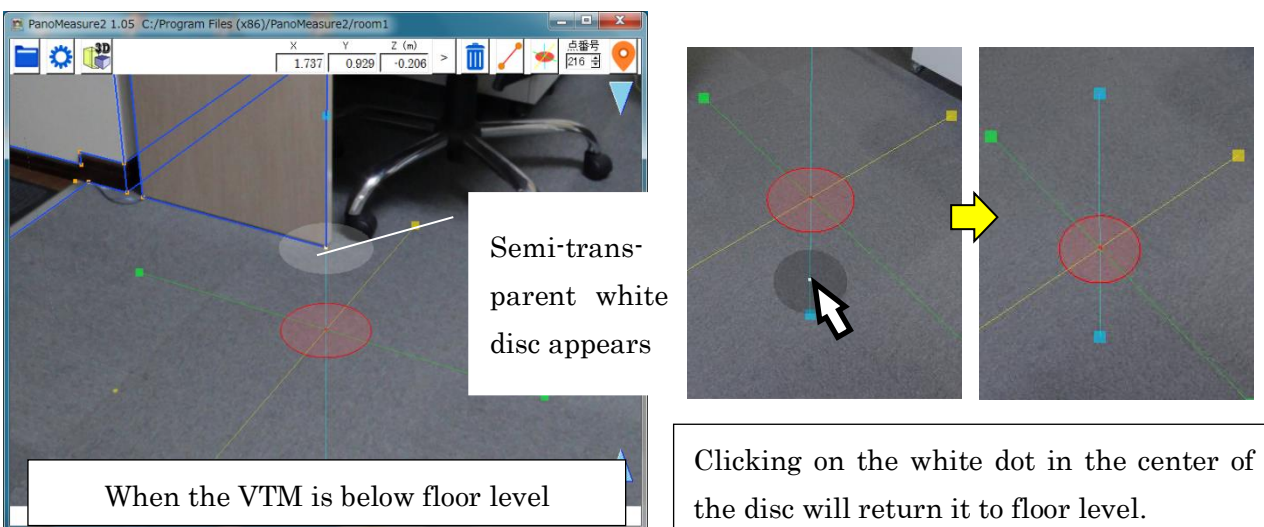

Another convenient function of the VTM shadow is the white dot in its center. Clicking on it will return the VTM to floor level enabling you to quickly draw or measure the dimensions of the floor.

2.6. Moving the VTM in the Depth Direction

You can move the VTM in the direction of the depth axis. Dragging the red dot-hat icon  located at the right of the screen up and down, will shift the VTM to the yellow axis. Dragging it up will make the disc smaller because the VTM is farther away. Dragging it down will make the disc larger because the VTM is closer.

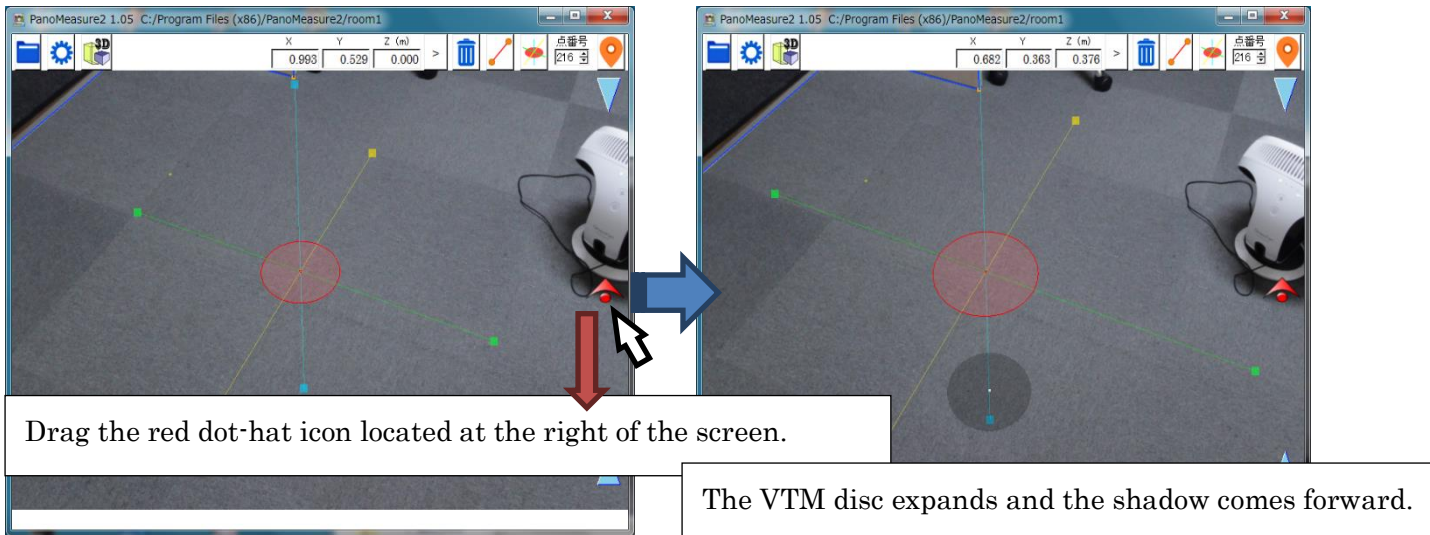

In addition to moving along the horizontal plane, vertical axis and depth axis, there are methods of moving the VTM in the vertical plane, by entering coordinates and by clicking previously measured points. These methods are explained in Chapter 5.

2.7. Expanding and Rotating the VTM

To measure the dimensions of an object or to draw its outline, first move to the edge of the object. Then, carefully align the axis of the VTM along that edge as shown below. When you click a VTM axis, it will lengthen and red triangles will appear beside it. (You have selected an axis.) By dragging a red triangle, you can rotate the VTM.

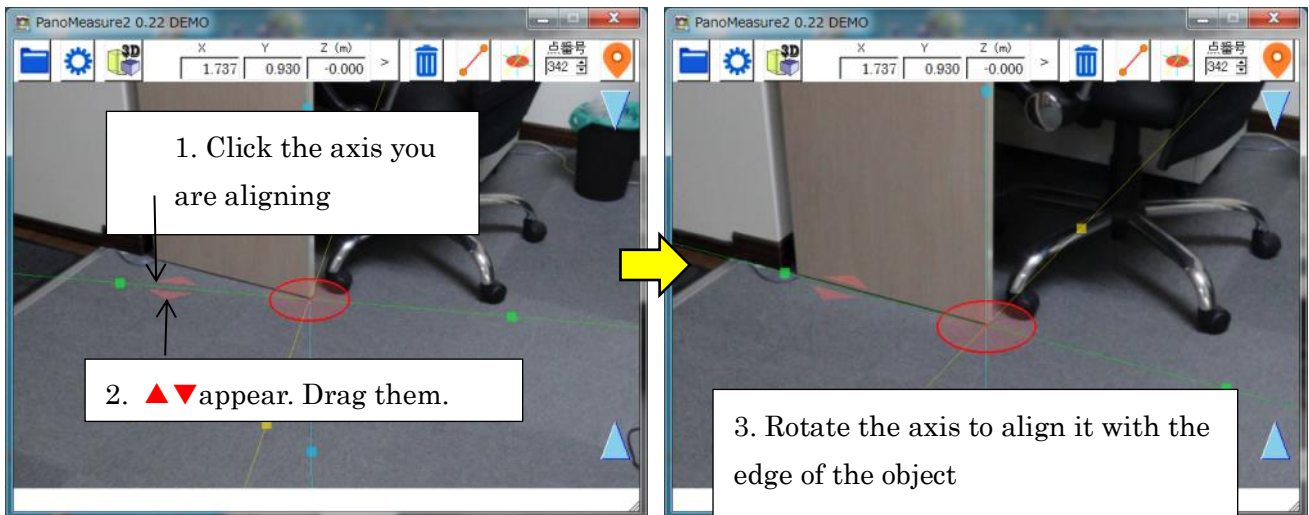

2.8. Measuring Dimensions

When the VTM axis aligns with the object to be measured, click on one of the square ■ icons that is the same color as the axis, to change to a new disc. ■ (the same color as the axis), change to a new disc. For example, as shown below, when you click the ■ on the green axis, the green disc will appear

in the position of the ■. The green disc will move along the green axis.

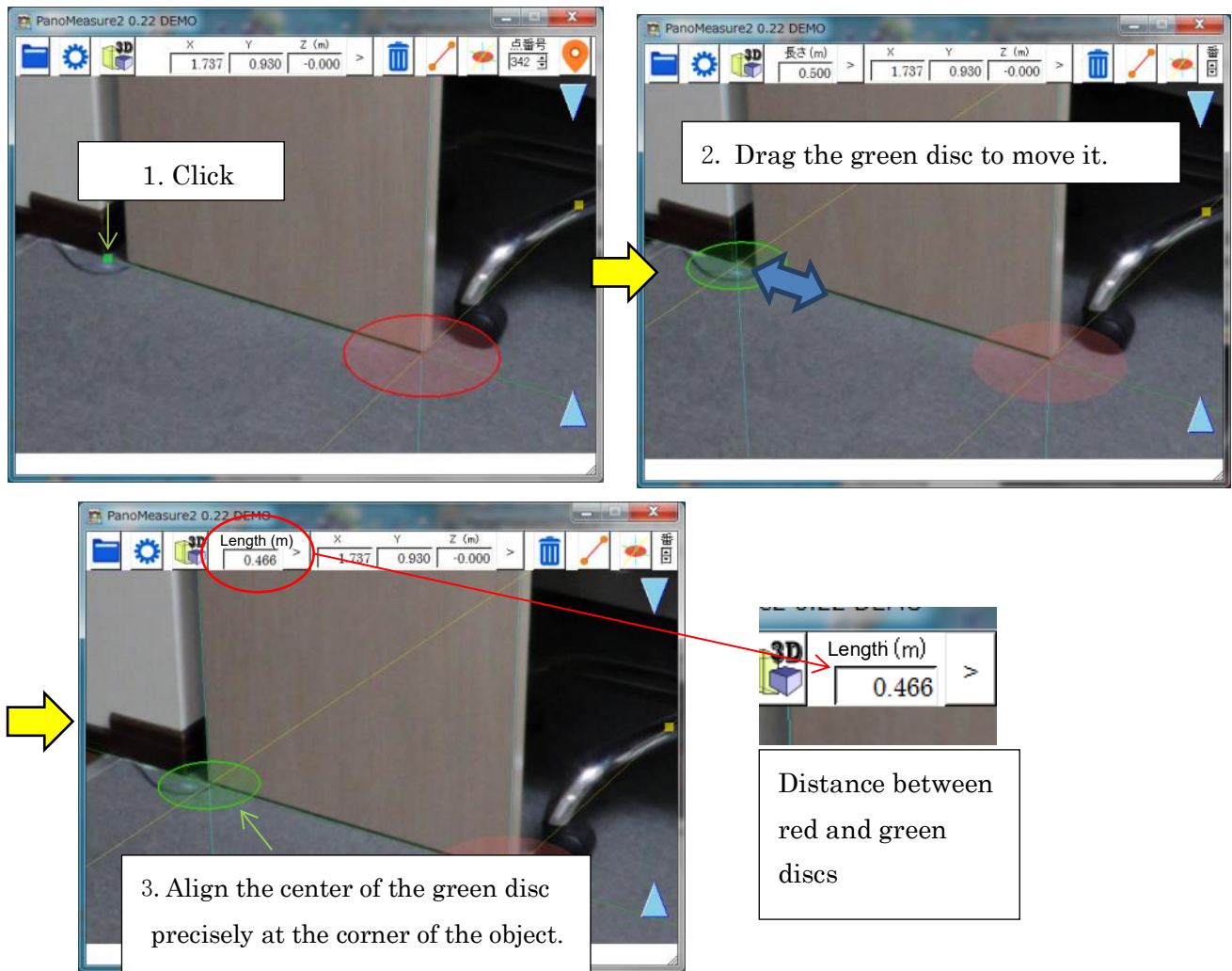

Align the center of the green disc precisely at the opposite corner (end point) of the object to be measured. As in the case of the red disc, note that the green disc has two orthogonal axes (yellow, light blue). Use these to precisely align with the next edge you will measure.

The distance between the red and green discs will appear in the dimensions box in the toolbar as shown above.

2.9. Rebooting the VTM

Double click on the image to delete the green disc and reboot (have it become short again as shown at right) the VTM. In this condition, the colored ■ of each axis extends 50 cm out from the center of the red disc and the radius of the red disc is 10 cm. Knowing these measurements provides a guide to the approximate dimensions of objects in the image.

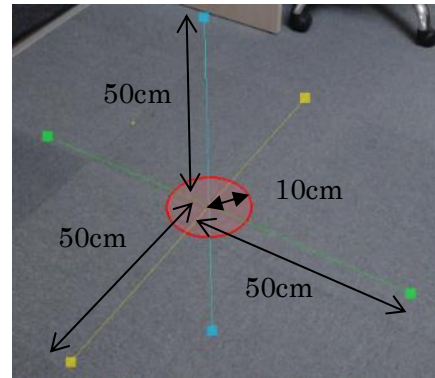

2.10. Rendered Images: Drawing 1: Drawing from Measured Points

Draw carpet squares to practice creating a rendered image. The carpet squares are 50 x 50 cm, providing a good subject on which to verify measurement accuracy.



1. Align the center of the red disc with a carpet square corner and rotate the axis to align it with the edge.



2. Click a green square (or yellow square) to adjust the length of that axis to that of the carpet square.

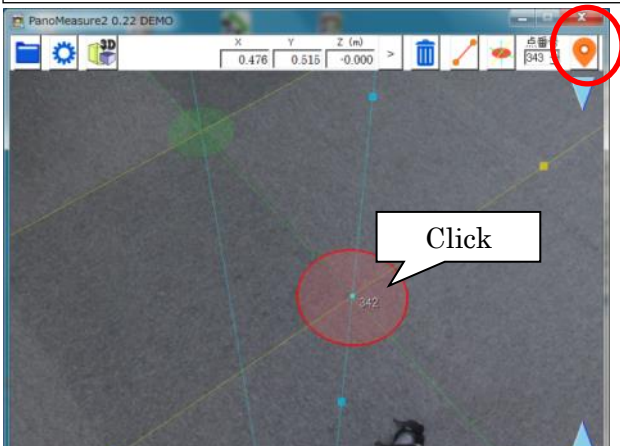

3. Click on the red disc to activate it and click  to plot the point.

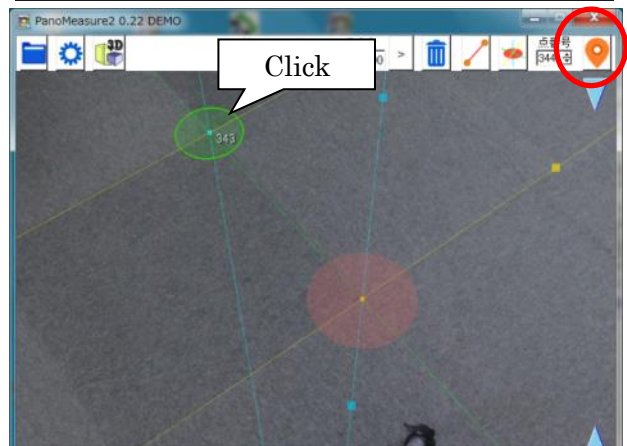

4. To plot the green disc, click on it to activate it and click  to plot the point.

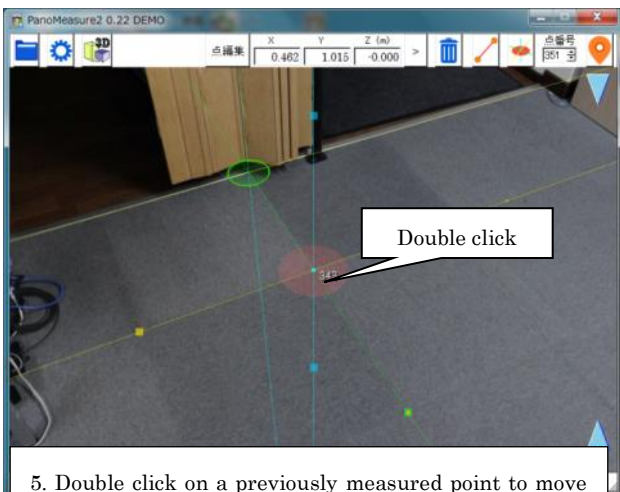

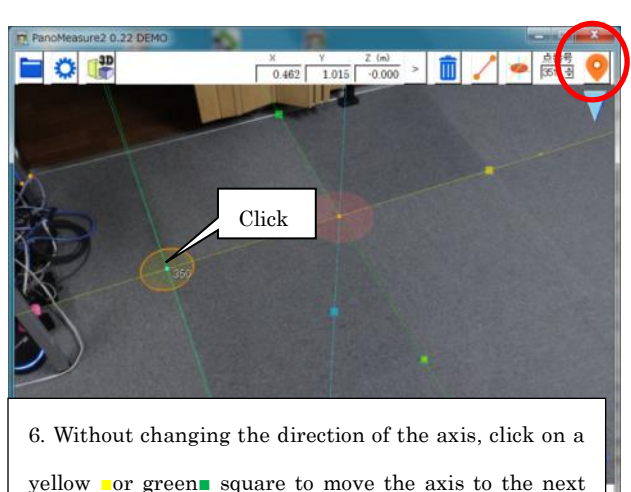

5. Double click on a previously measured point to move the center of the VTM to that position.

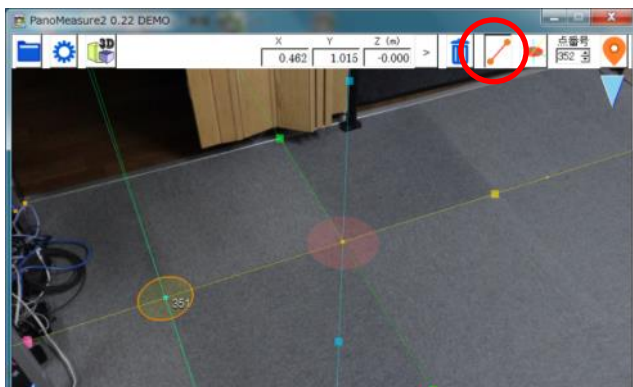

6. Without changing the direction of the axis, click on a yellow square or green square to move the axis to the next corner and plot it.

2.11. Rendered Images: Drawing 2: Connecting Points



1. The cursor will change to line connection mode when you click on the . The cursor will change to a .

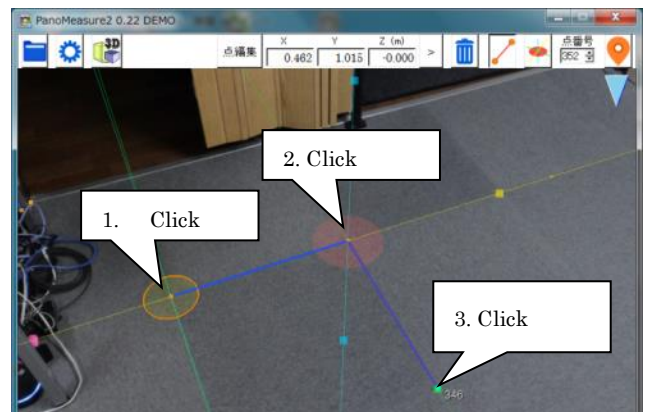

2. Consecutive clicking on other corners will connect them with lines.

2.12. Displaying 3-D Drawings with Measured Lines

Clicking on the  icon will display the 3-D rendering.

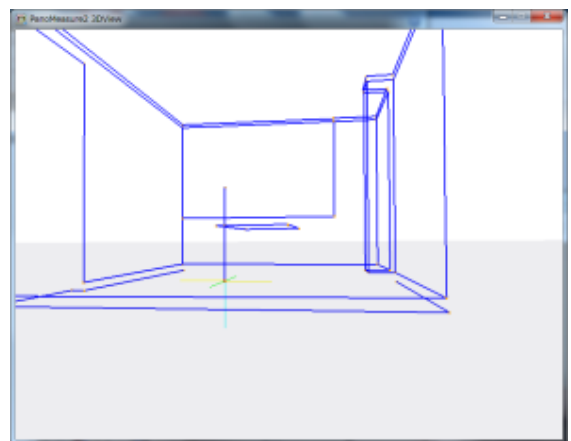
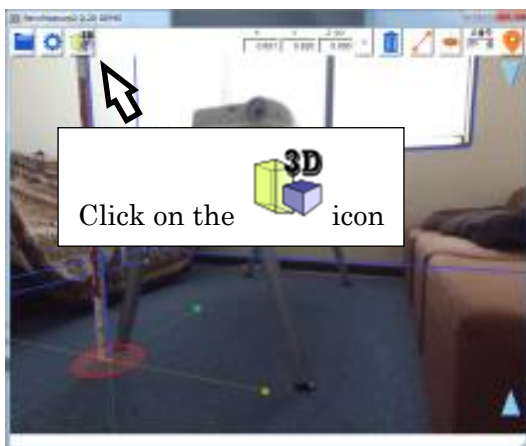

Change your perspective by dragging on the 3-D View window.

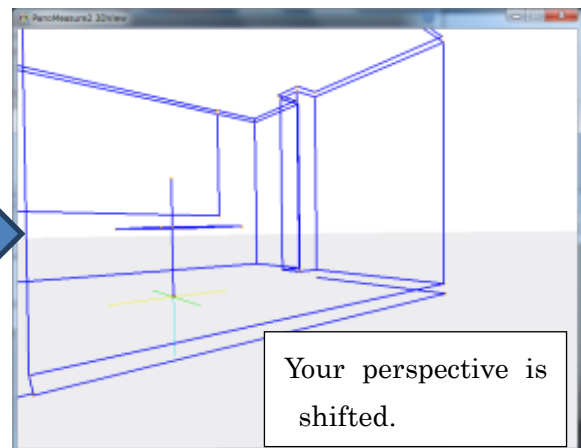
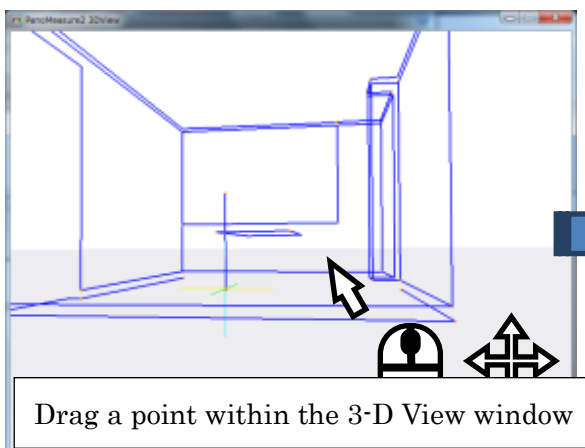

3. Changing Images

3.1. How to Open a Saved Panorama Image

The demonstration data features two image folders entitled “Room 1” and “Room 2.” Room 1 opens automatically when the program loads. You have the option to change the image you will manipulate. Practice by opening room 2.

Clicking on the  will show you the pull-down menu. Click on “Select panorama image folder” and the panorama photo selection dialog box will appear. Here, you can select (change) the panorama image folder.

In the panorama photo selection dialog box, click on the  and a file selection dialog box will appear. Change the file to “Room 2” and select a panorama photo. (“front.jpg” or comparable compression type). Click on it and the words, “Panorama photo folder name” will change to the name of the image you selected.

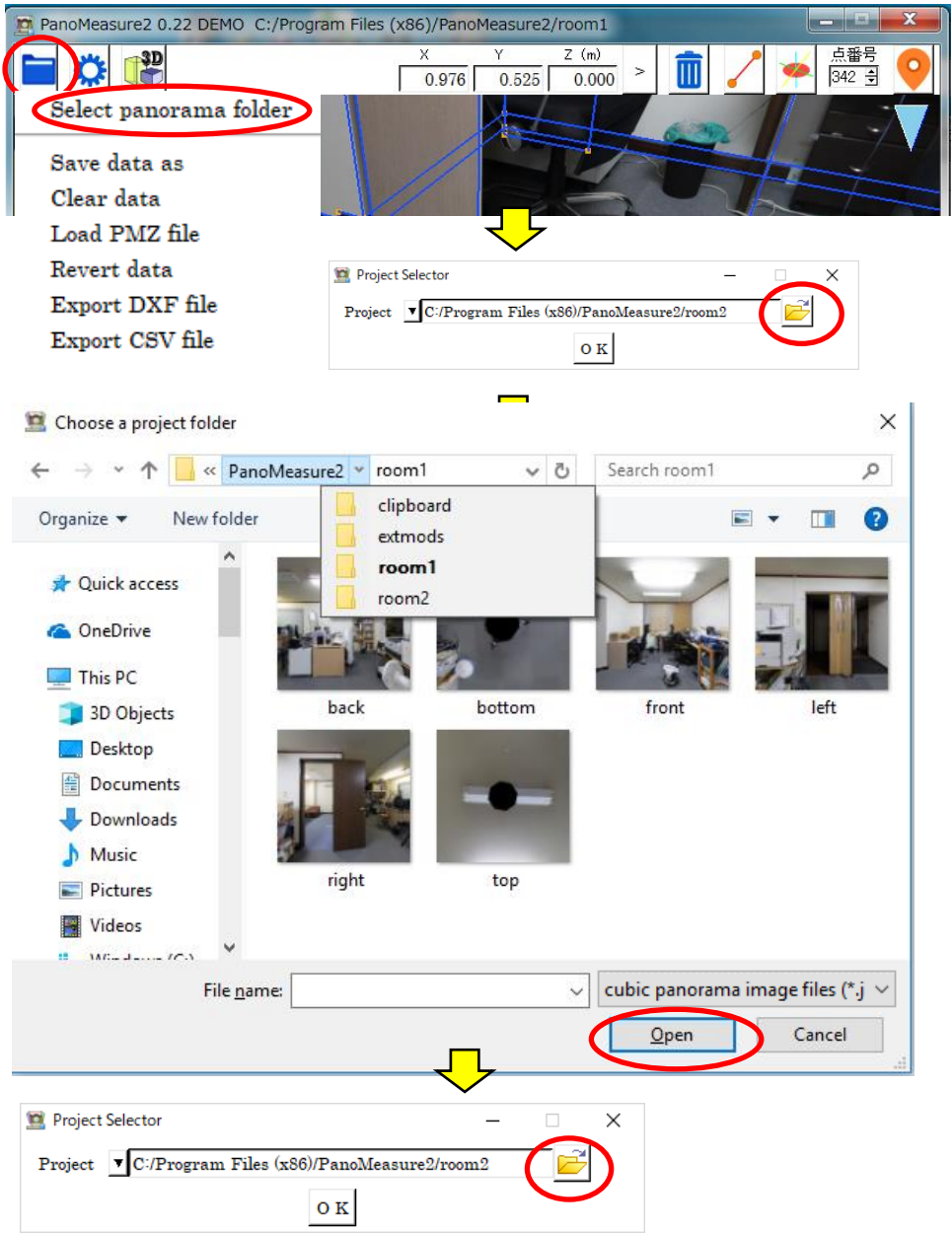

Clicking on “OK” will change the panorama practice image.

Alternatively, you can directly edit the title of the file in the panorama photo folder title dialog box, replacing Room 1 with Room 2.

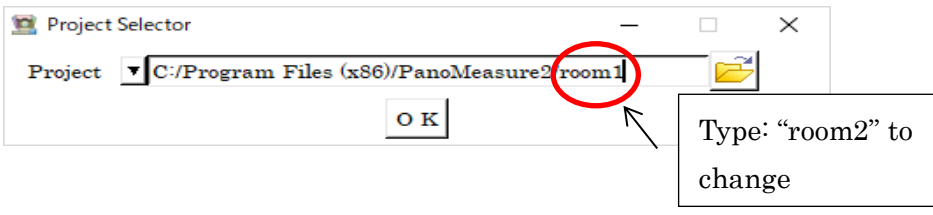

If you have loaded photos, clicking on the [dropdown arrow] will show your saved photos. Select one from that history.

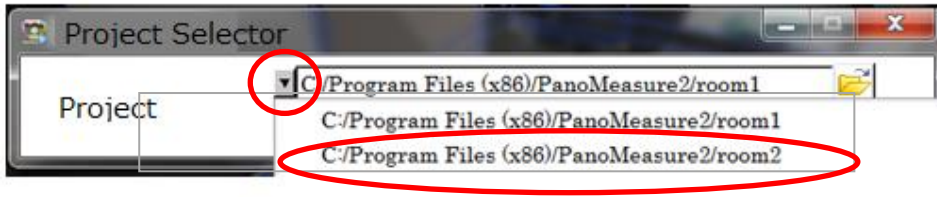

3.2. Loading Images taken with a Ricoh Theta

PanoMeasure2 comes with a tool to enable the use of panorama images shot with the Ricoh Theta omnidirectional camera. PanoMeasure2 uses the Ricoh Theta storage format known as equidistant cylindrical projection, but images in this format cannot be loaded directly to Panomeasure2. They must first be converted to cubic panorama image format. PanoMeasure2 includes Theta Cube software for convenient image conversion.

You can add images by dragging and dropping them into a folder.

Select a Theta image folder.

Measure and enter the height from the floor to the center of the lens (in meters).

The Theta Cube uses the EXIF anti-distortion data from images taken with a Theta camera. Check this box.

Drag and drop source panorama images.

Thumbnails of the selected images will appear.

Image file name

Camera position number

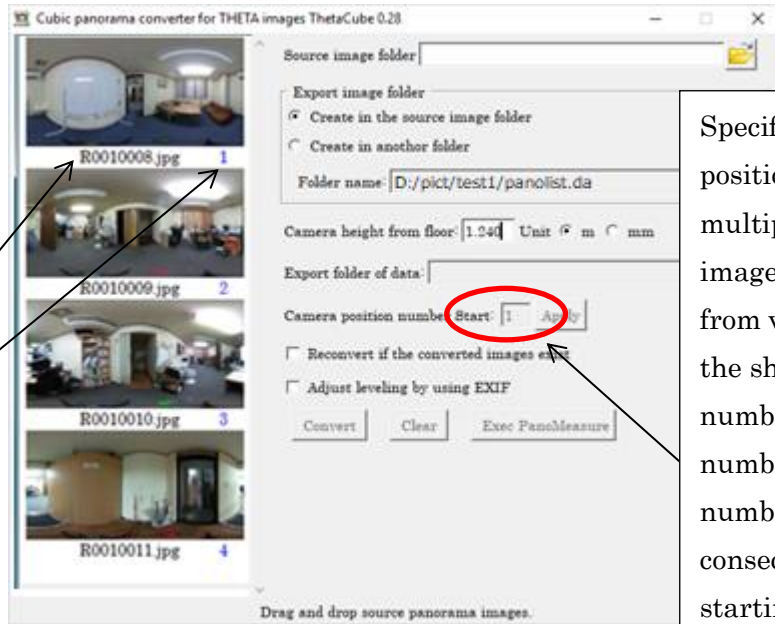

Specify the shooting position number when multiple omnidirectional images have been shot from various positions. If the shooting position numbers start with a number other than 1, re-number them consecutively now, starting with 1.

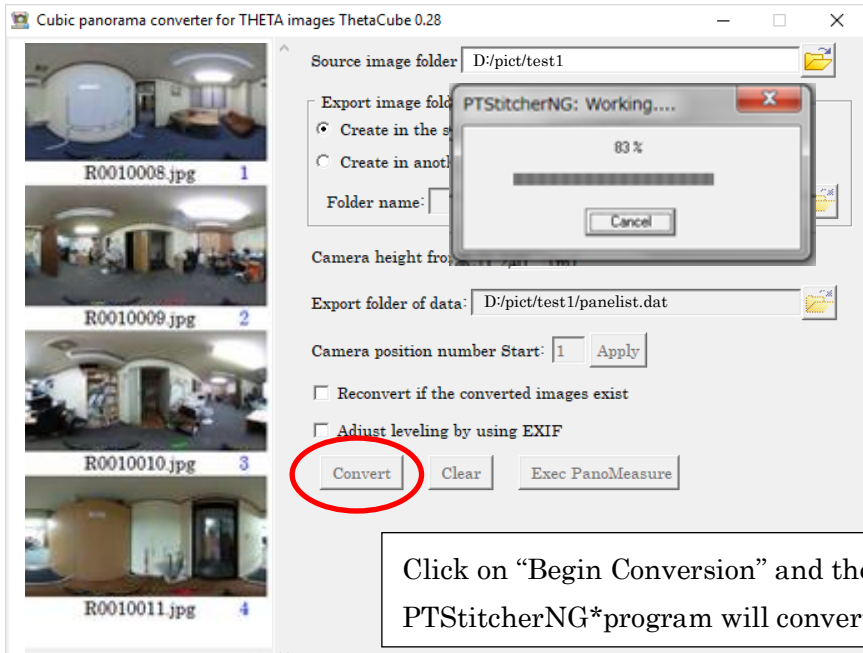

Click on “Begin Conversion” and the PTStitcherNG*program will convert each image.

*The Theta Cube software uses PTStitcherNG, a panorama image projection conversion program created by Helmut Dersch.

<http://webuser.hs-furtwangen.de/~dersch/> (c) 2008 2009 2010 Helmut Dersch

Images converted by the ThetaCube will each be stored in its own cubic panorama folder.

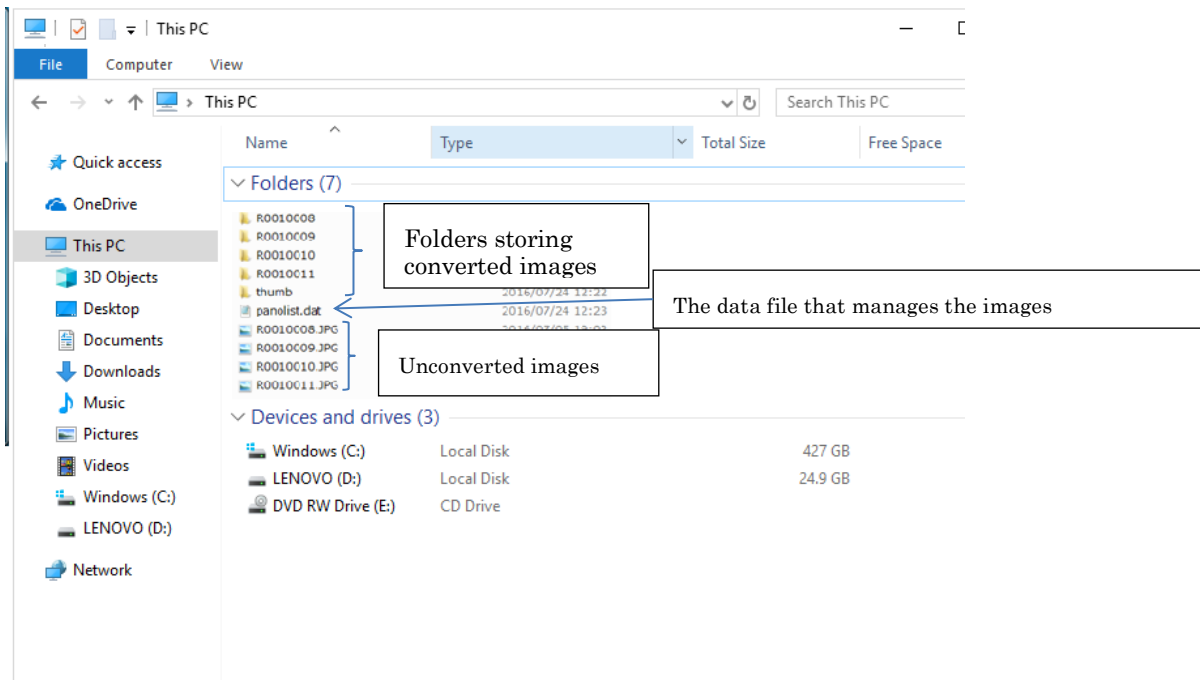

Converted Images Folder (for separate cubic panorama images)

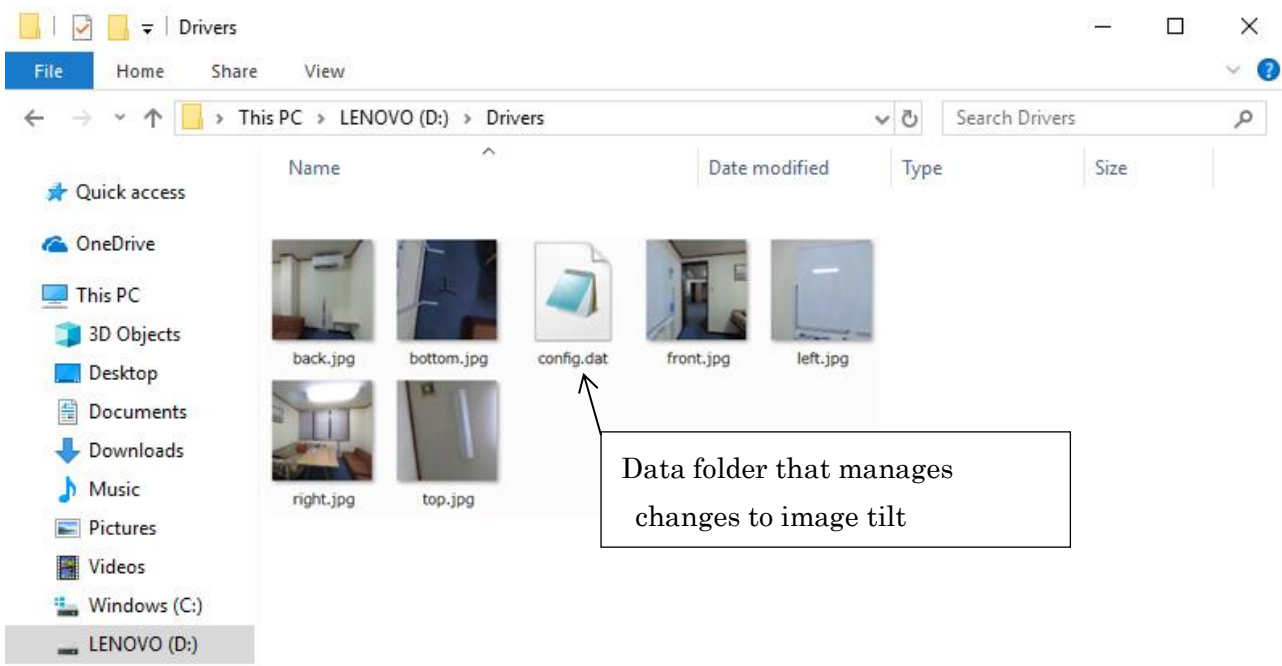

Specify and load this folder in the PanoMeasure2 Select Panorama Photos Dialog Box.

3.3. Adjusting Ricoh Theta Image Levels

As the accuracy of the Ricoh Theta inclination sensor (level) feature is not sufficient for measurement, you must adjust the horizontal to attain the desired level of precision. To do this, select Adjust leveling  from the toolbar. This is only functional if you have converted your Ricoh Theta image with Theta Cube software.

There are two methods of making adjustments to the horizontal plane.

- A Using a vertical line
- B Using a horizontal line

“B” is easier than “A,” but requires shining a horizontal laser sight beam from the exact height of the lens. As this is not always possible, “A” is the method explained below.

Activating the “Adjust leveling” function will bring up the screen below. The light blue line horizontally bisecting the screen represents “horizontal” in the image you are currently manipulating. (This line represents the horizontal plane that passes through the lens center.) We will refer to this line as the virtual horizontal line. The green line vertically bisecting the image is the virtual vertical line. There is also a yellow virtual vertical line that bisects the image (perpendicular to the virtual lines you see), but cannot be seen in the figure below.

It should be noted that in the sample images attached to the distribution program, you can see a laser beam showing true horizontal. In the figure below, the discrepancy in the virtual and true horizontal lines indicates that the camera was not level. After horizontal adjustment, the light blue virtual horizontal line should align perfectly with the true horizontal line.

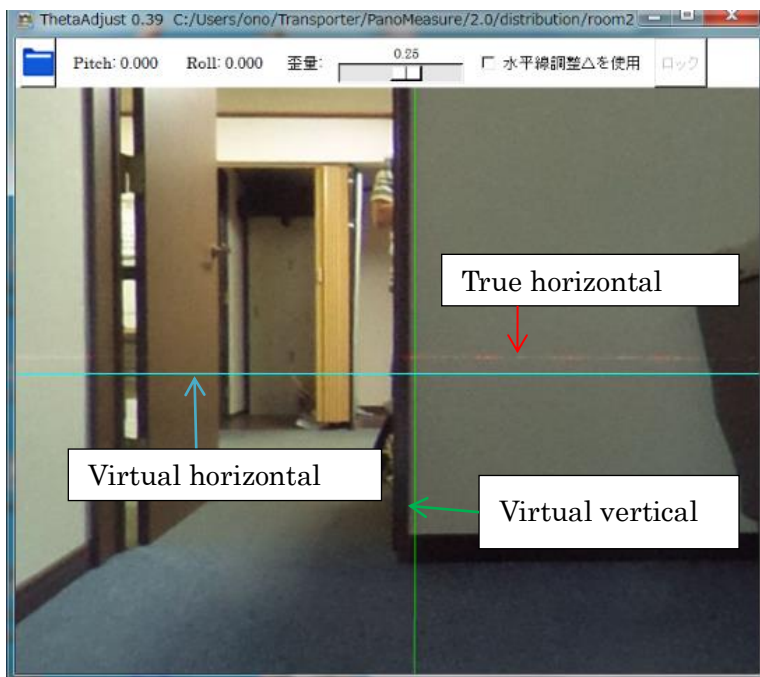

Step 1

Click on the virtual horizontal line near the vertical edge and the green vertical line \Rightarrow a red virtual vertical line will appear.

You can zoom in and out of this screen, just as you did with the main PanoMeasure2 screen. After sufficiently enlarging the image, click on the virtual horizontal line (—) where the virtual horizontal and vertical edges meet. This will cause a red virtual vertical line (|) to appear.

Step 2

Click on the red virtual vertical line (|) \Rightarrow a red \triangle triangle will appear
 \Rightarrow Drag the red \triangle triangle and rotate the image until the vertical edge aligns with the red virtual vertical line

Enlarge the image and closely compare the vertical edge and the red virtual vertical line adjusting to make them as parallel as possible.

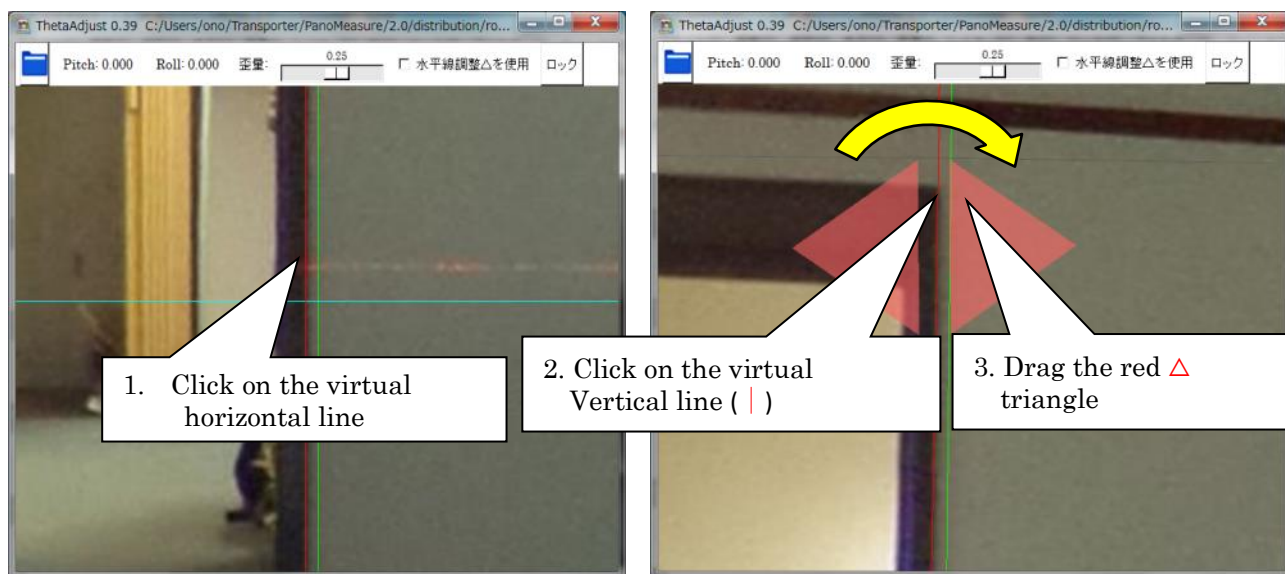

Step 3

Lock in the virtual vertical line \Rightarrow The red virtual vertical line (|) will become purple.

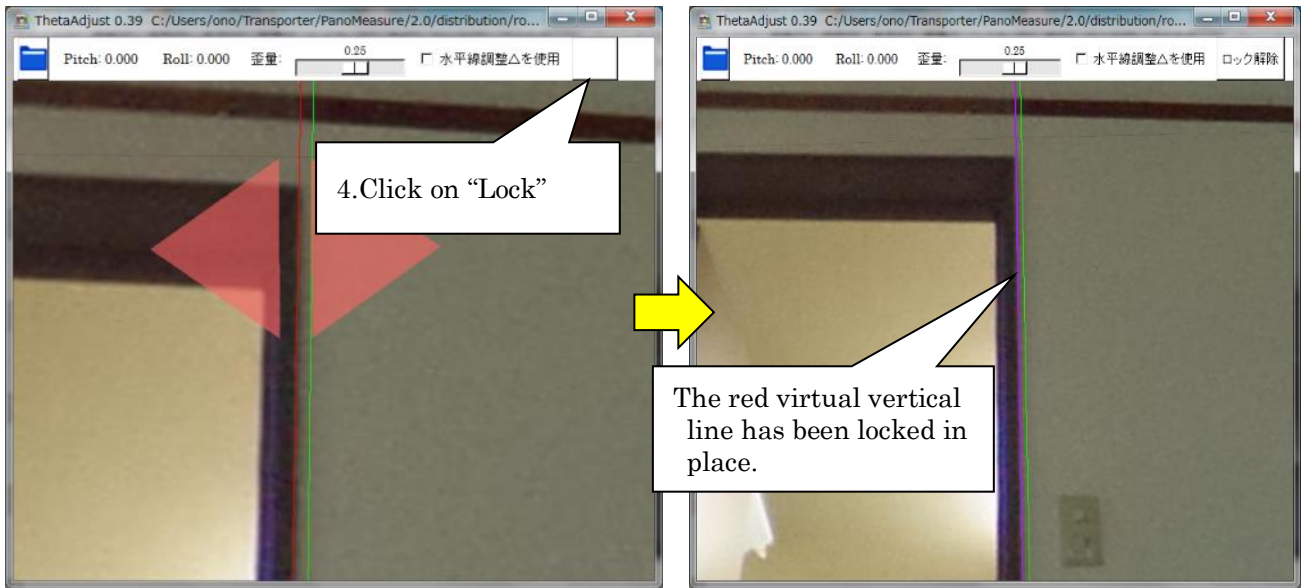

Clicking on “Lock” at the upper right of the screen will change the color of the virtual vertical line (|) from red to purple and lock it in place. Click “Unlock” to delete the purple virtual vertical line. When you create another red virtual vertical line and click to lock and turn it purple, the previously locked line will automatically be deleted. Only one line can be locked in at a time.

Note:

In 0.39 and earlier versions of PanoMeasure2, moving virtual vertical lines would disturb lines that had previously been aligned with edges and alignments would have to be repeatedly adjusted. This lock function update provides a way to adjust virtual vertical lines without influencing the angle of previously adjusted lines.

Step 4

Create a red virtual vertical line near the yellow virtual vertical line (|) and make horizontal adjustments as you did in step 2 above.

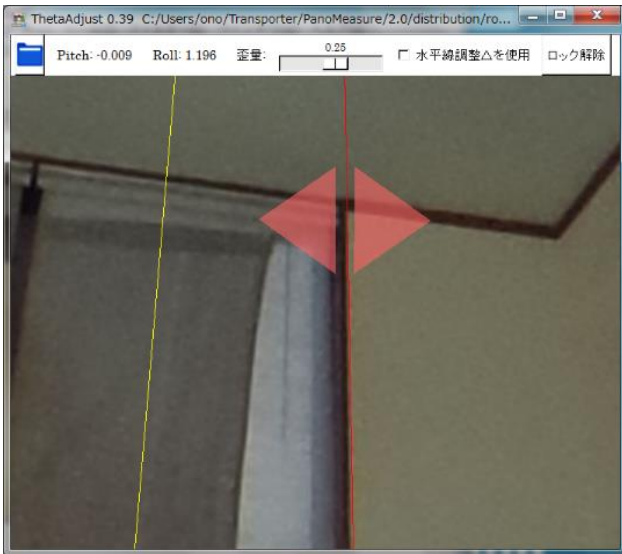

Using the lock function, you can more easily make horizontal adjustments (with a minimum of steps) by working with it in combination with the nearby green and yellow vertical lines.

Step 5 (Image distortion adjustment)

Near a horizontal edge, click on the solid green vertical line ⇒ a dotted horizontal line will appear

⇒ Click on the dotted horizontal line ⇒ a red △ triangle will appear

⇒ Drag the red △ triangle until the dotted horizontal line is parallel with the horizontal edge

Our proprietary research has proven that distortion results in images assembled from two fisheye lenses on a Ricoh Theta. Use the “Distortion parameter” function to adjust this. Distortion causes horizontal lines to bend at junctions in an image (for example, along the line where the wall meets the ceiling). Use the “Distortion parameter” function to rectify this, straightening the horizontal line. Use the dotted horizontal line as a reference.

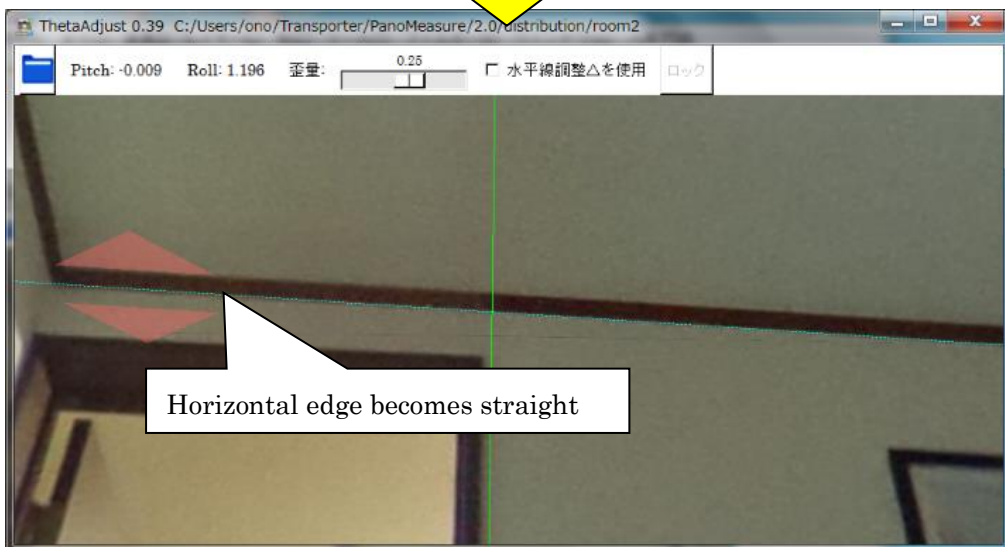
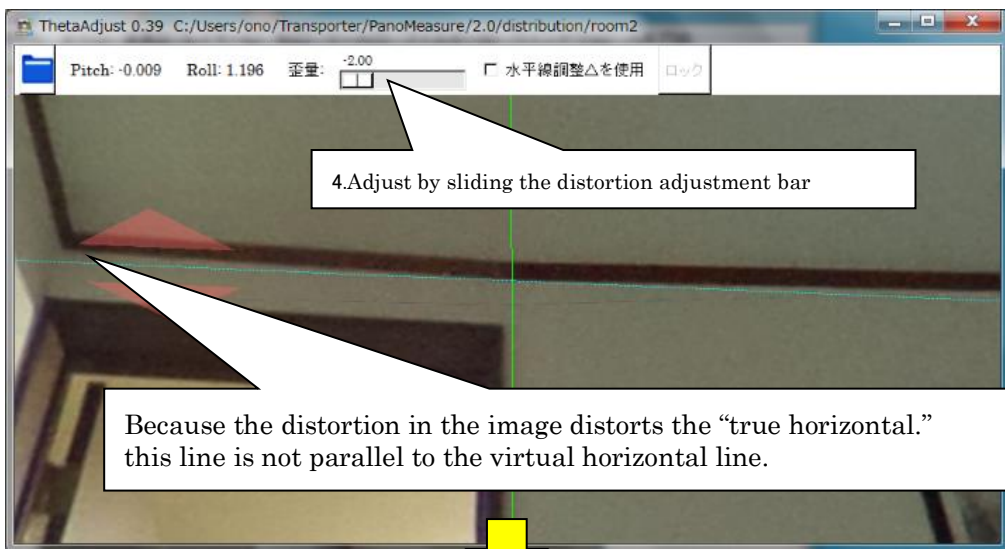

After horizontal adjustments are complete and that window is closed, the results will be incorporated into the PanoMeasure2 program.

3.4. Adjusting Camera Height

To perform accurate measurement with the PanoMeasure2, the camera height (from the floor to the center of the lens) must be accurate to within 1 mm. Using a tape measure to accurately set the camera height, however, is quite a difficult proposition. We strongly recommend vertically positioning a surveyor's rod or long measuring stick near the camera and reading the camera height from the image.

If you are shooting the image with a Ricoh Theta the low resolution will make it difficult to read the scale in millimeters. We suggest using a rod or stick with 5 mm units.

The figure below shows how to use a rod when adjusting the height of the camera. Note that you will need to input the approximate camera height when you load the image.

First, move the VTM near the vertically positioned surveyor's rod, as shown below.

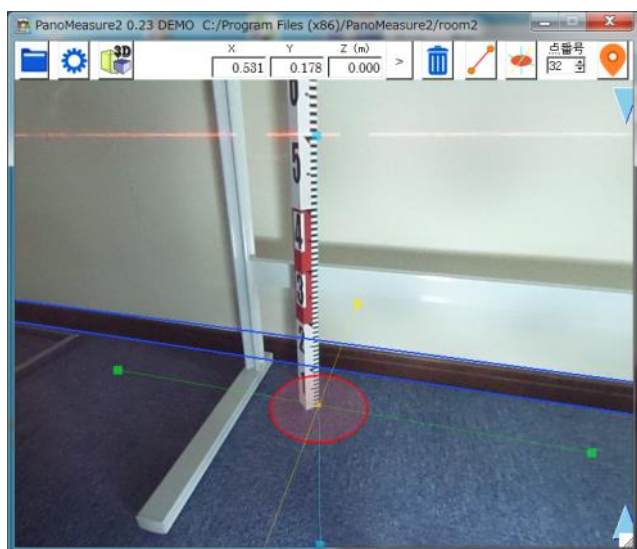

Next, select "Camera height" from the scroll down menu under settings. This will reveal the height of the camera position for this shot. Input the position height in the Z(m) box/field and click ">."

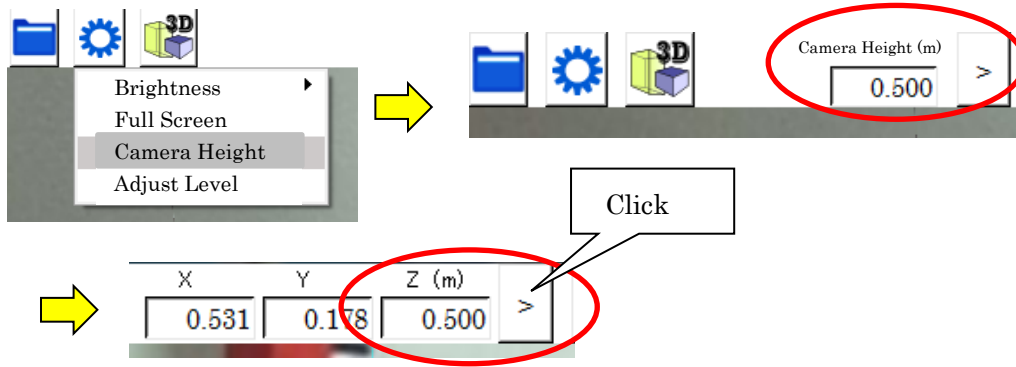

The VTM will then move to the camera position height you input and a horizontal line will appear. Use this horizontal line to read the camera height from the rod or stick with greater accuracy.

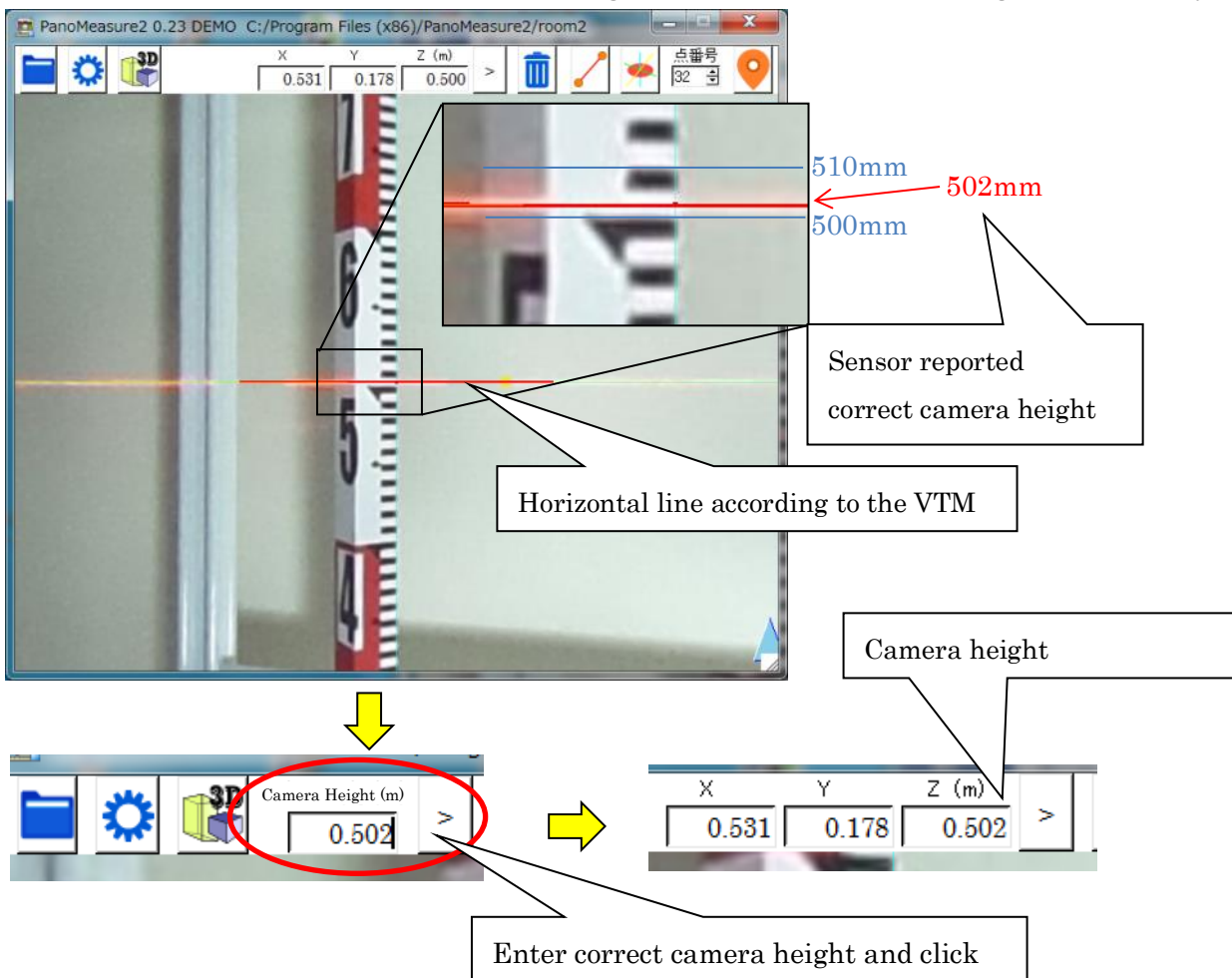

4. Editing Points and Lines

4.1. Selecting Points for Measurement

To draw a line between two points or to edit points you must first select the points. A selected point will turn light blue and a number will appear for each one.

Three methods for selecting points are shown below.

- Click to select a point (selection of a single point only)

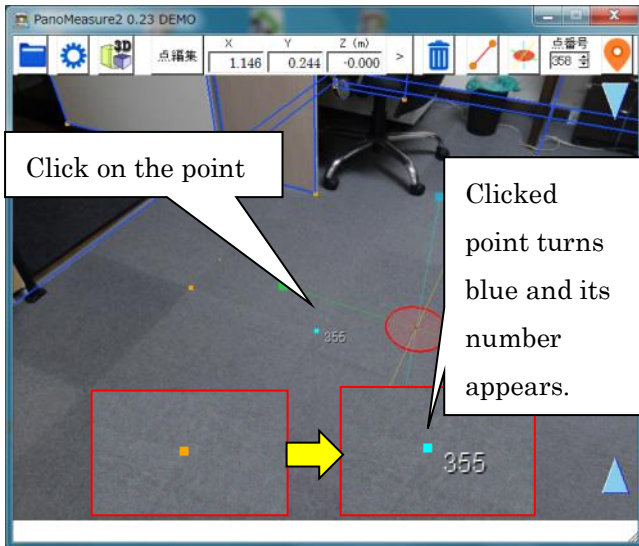

- Right-drag (on a tablet, do a long touch and swipe) around the target area

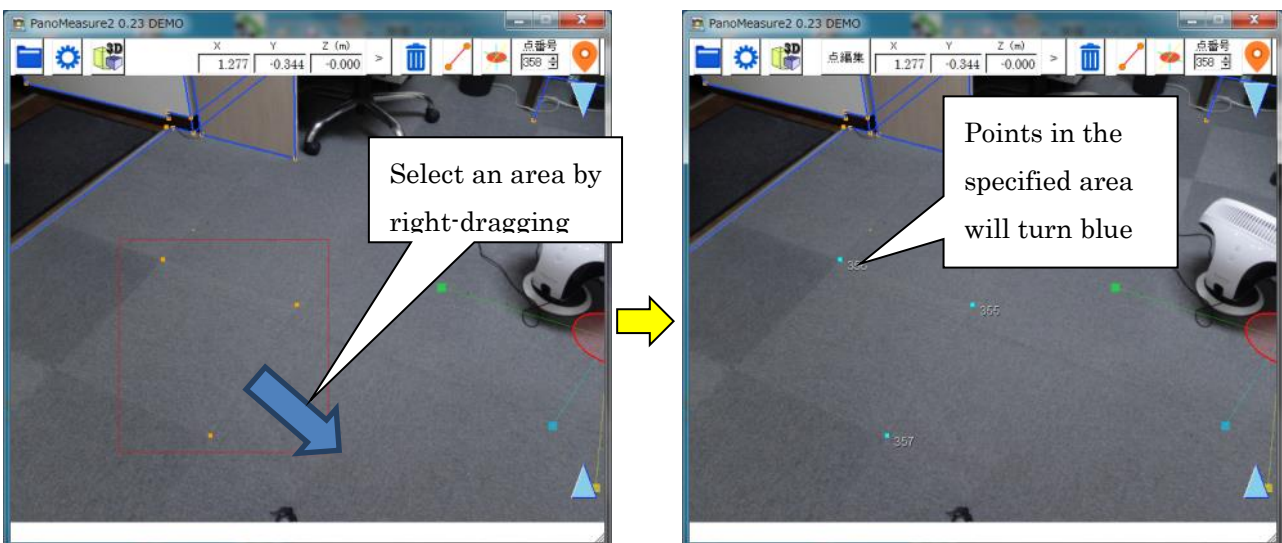

Right click on a selection to cancel it. (On a tablet use a long touch.)

- Holding down the Control key to make Multiple Selections

Holding down the Control key will convert the mouse cursor to a "Multiple Selection Mode" icon as shown below.



You will be able to select multiple points and lines simultaneously.



4.2. Editing Points

To edit points, click “edit point” in the toolbar and the point editing dialog box will appear. Edit the point number or coordinates in the dialog box and click”>” to activate it/them. When you have selected multiple points you can use the tab key to change to the point you wish to edit.

X	Y	Z (m)
1.146	0.244	-0.000

When one point is selected

Point No.	X	Y	Z
355	0.988	0.533	-0.000



When multiple points are selected

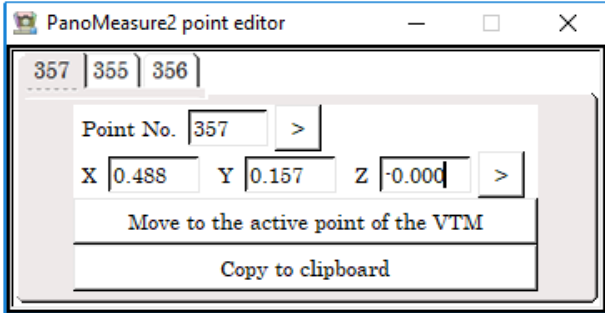

In addition, when you click on "move to the point activated by the VTM," the point you are editing will move to the center of the active VTM disc.

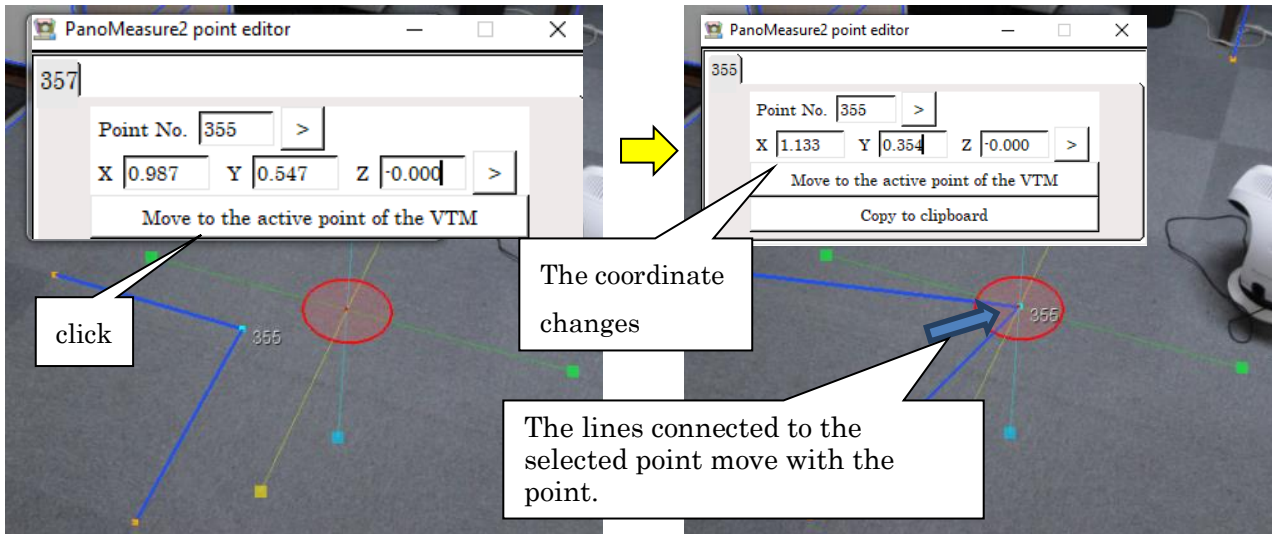

If you click the button of "Copy to clipboard", you can record the coordinates of selected points to the clipboard.

4.3. Selecting Lines

When you click a drawn line it will turn red, showing that it has been selected and the length of the line will appear in the toolbar (see below). You cannot select a point and a line at the same time.

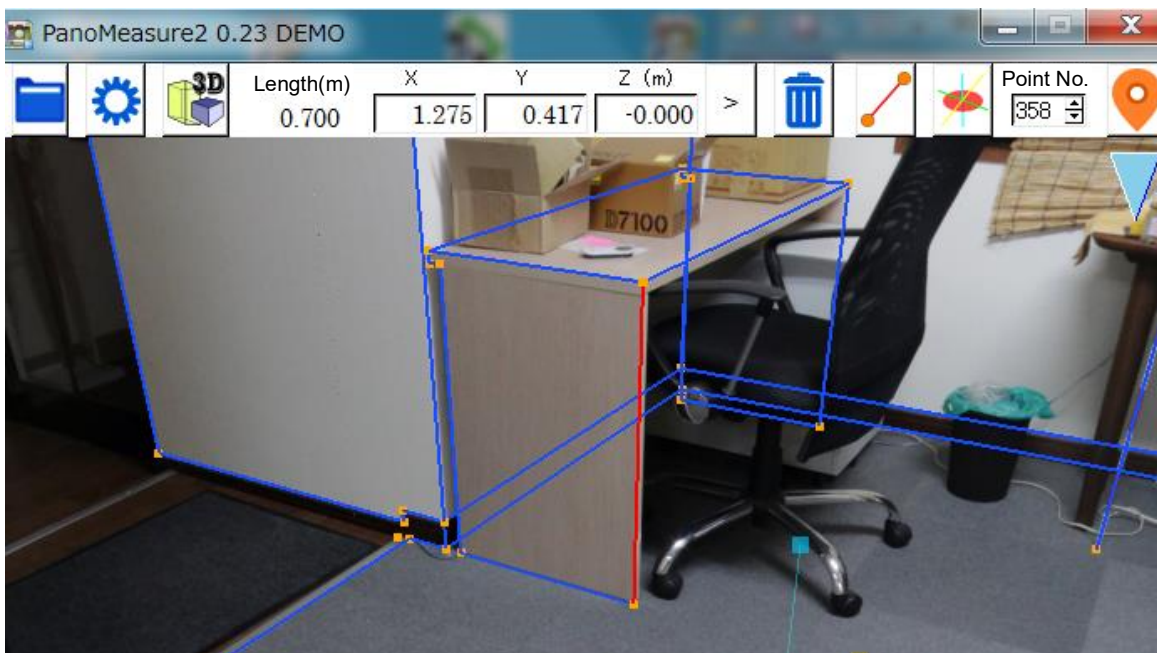

4.4. Deleting Selected Points or Lines

To delete selected points or lines click on the  in the toolbar. If the point you wish to delete is the end of a line, the line will be deleted when you delete the end point.

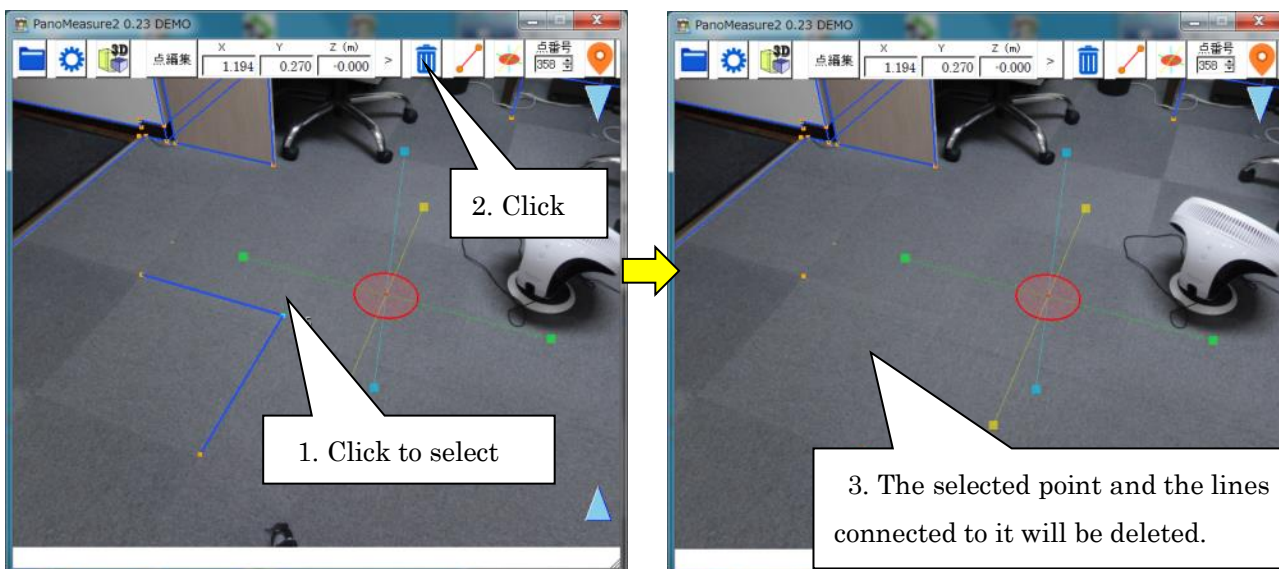

5. Using the VTM (Virtual Tape Measure)



5.1. Moving the VTM

When you drag the disc in the center of the axis of the VTM the VTM always moves along an identical horizontal or vertical plane. (It cannot move along a slant, incline or slope.) For example, starting with the default condition of 0.0 m in which the VTM is on the floor and dragging the red disc, will move the it horizontally across the floor at a height of 0.0 m. This directional movement occurs because the software is in “VTM red disc mode” (horizontal movement mode).

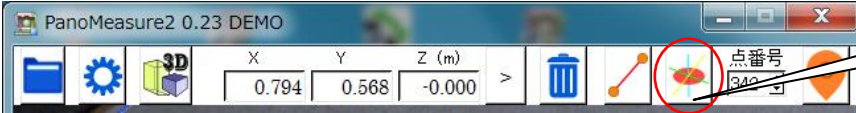
Clicking on “drag modes” in the toolbar changes the disc (from red to yellow to green to red) and changes the plane in which it can be dragged.



Drag modes

Red Disc Mode	Yellow Disc Mode	Green Disc Mode
		
<p>The VTM moves in the plane of the yellow or green axes (in the horizontal plane)</p>	<p>The VTM moves in the plane of the yellow and blue axes (moves in the vertical plane)</p>	<p>The VTM moves in the plane of the green and blue axes (moves in the vertical plane)</p>

The example below shows the side of a desk drawn in Green Disc Mode.

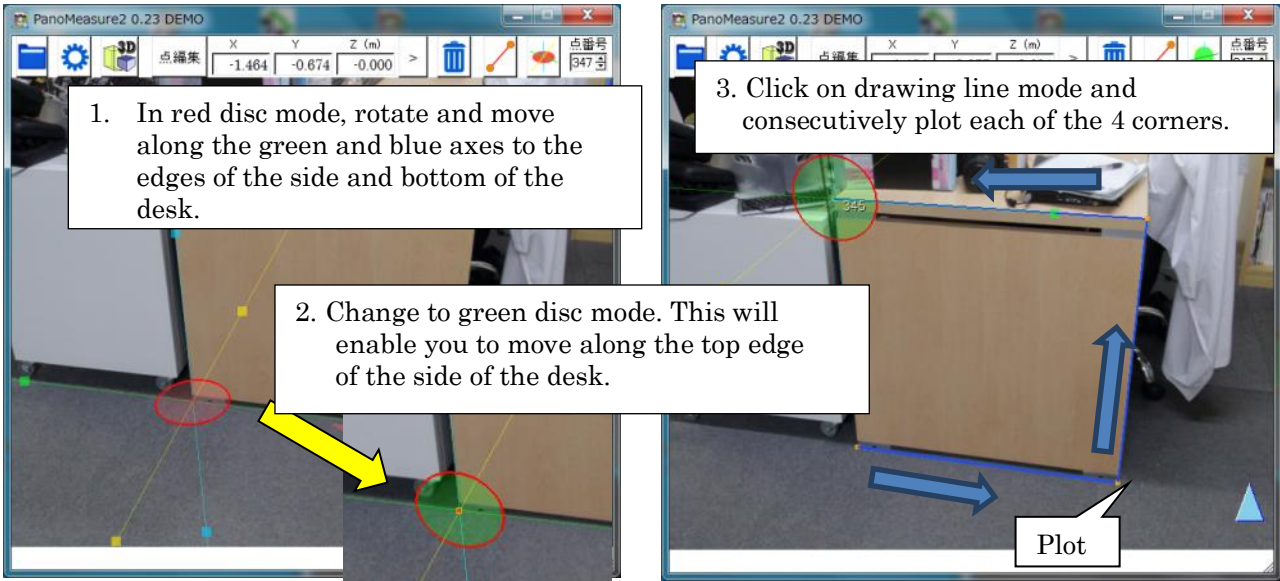

5.2. Other Ways of Moving the VTM

Up until now instructions have focused on how to drag the axis-centered disc. Here are some other methods:

- Click and drag the light blue icons (▲ ▼) to move the VTM vertically (up or down).
- Double click on a point to jump to it.
- Enter the coordinates for a point to move to it.

The use of coordinates to move to a point will now be explained. For example, measure the height from the floor to the ceiling in advance. You can then specify that height and use it to move, as follows.

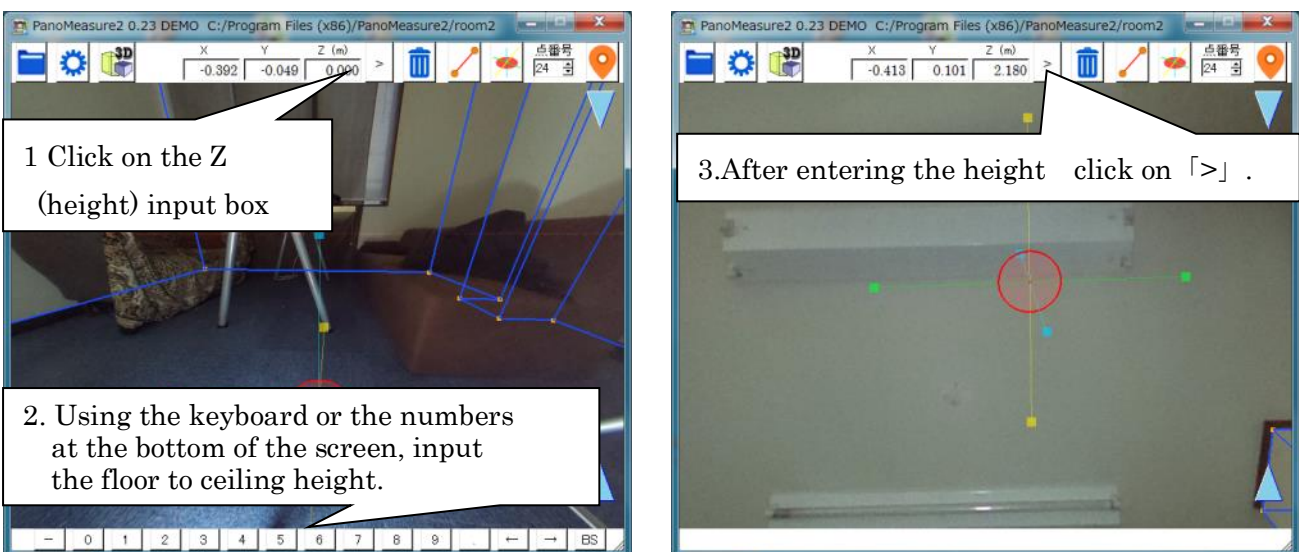

5.3. Aligning the Axis Parallel to Previously Measured Lines

When measuring along a wall, you often need to align the VTM axis, with a previously measured line. To do this, select the previously drawn line by clicking on it and slowly rotate the axis of the VTM. When the line you selected and the axis are parallel, the axis disc will turn red.* Stop rotating the axis at this point. You have now aligned the direction the axis faces with the previously drawn line.

*Color-blind users: Note that if you drag the axis slowly enough, you can notice it stops rotating when it and the previously measured line align. This is the moment when it turns red.

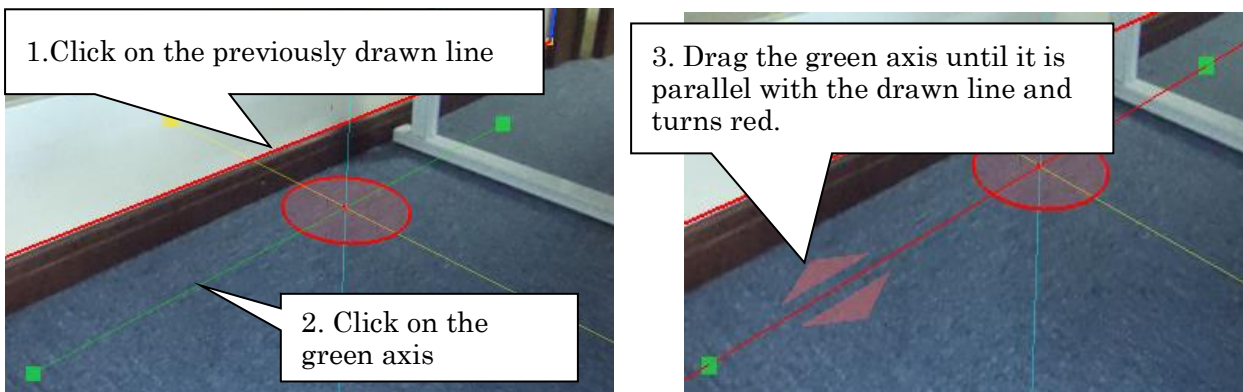

5.4. Setting the VTM for a Distance Between Two Points

If you use the box (■) on the VTM axis that is the same color as the axis to measure a line, its length will be recorded and stored until the VTM is initialized. (Double clicking on an image will initialize the VTM and automatically shorten any expanded axes to their default length.) Taking advantage of this ability, record the distance between two points to plot and measure unseen points. For example, in the photo below we want to measure and draw the edge of the wall and pillars perpendicular to the floor. We can draw the top corner of the wall on the right side because we can see it, but the edge of the left wall is hidden by the sofa and the pillar (vertical support). We will assume that the height of the edge of the left and right walls is the same. Set the height of the right wall in the VTM and use it to plot the top and bottom corners of the left wall as shown below.

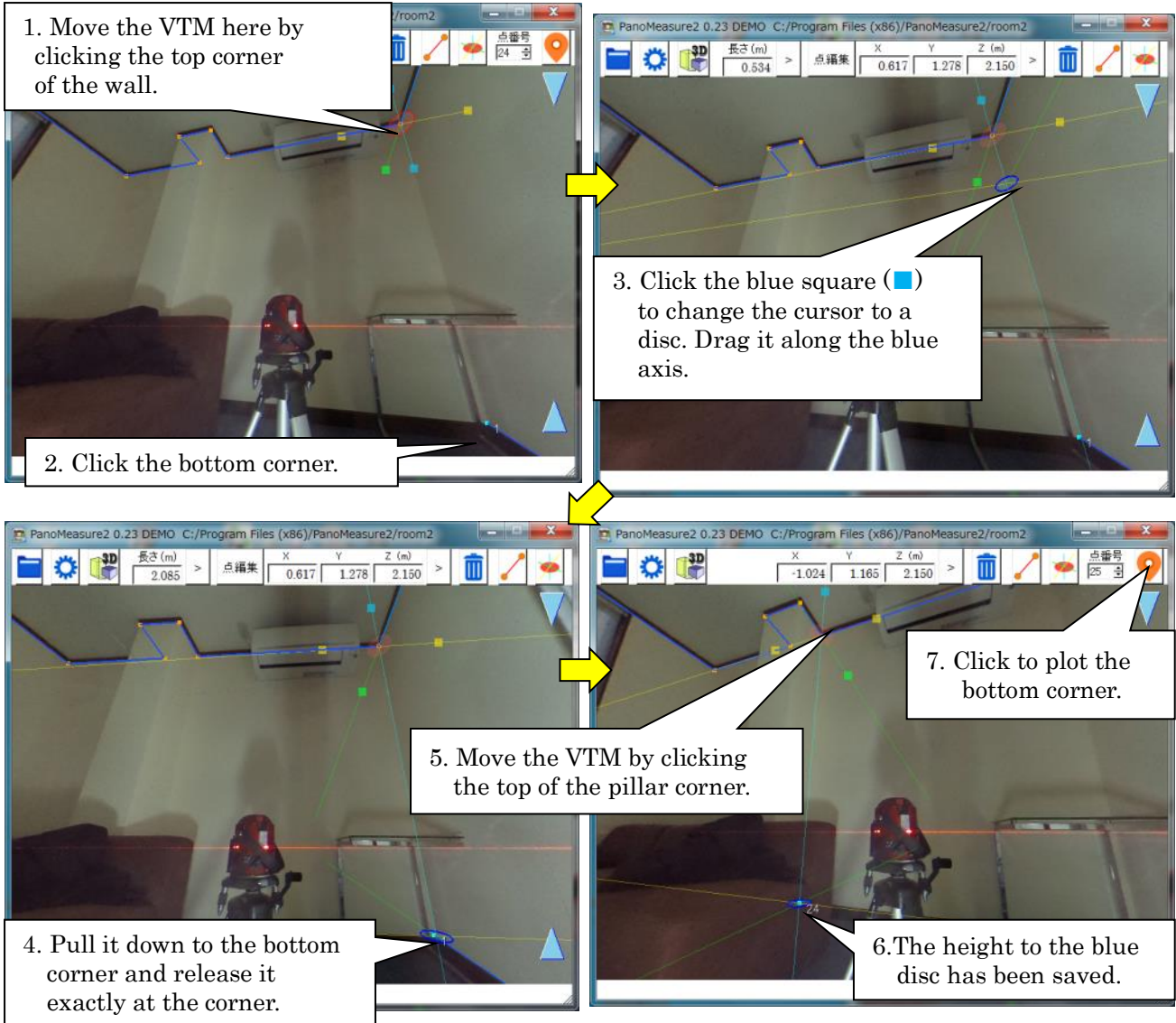

Steps 5. through 7. enable easy plotting of end points along the pillar, wall and other corners which cannot be seen. To complete the drawing of this space, connect the plotted points.

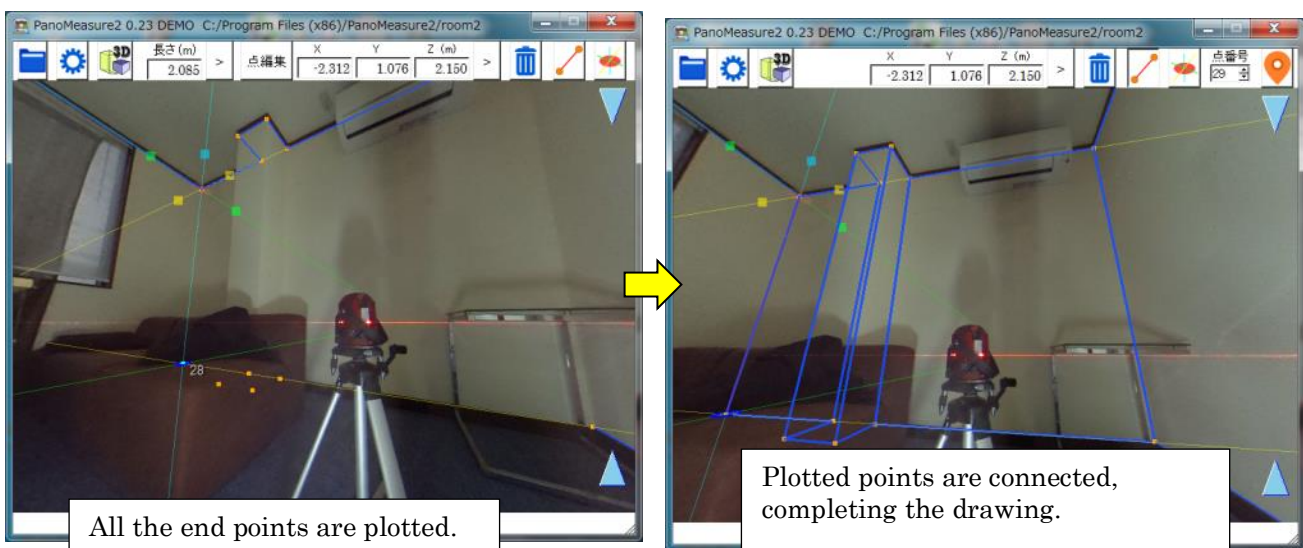

5.5. Making Use of the Orthogonality of the Axes to Draw Objects and Spaces

The example below shows the drawing of a desk that takes advantage of the orthogonality of the axes.

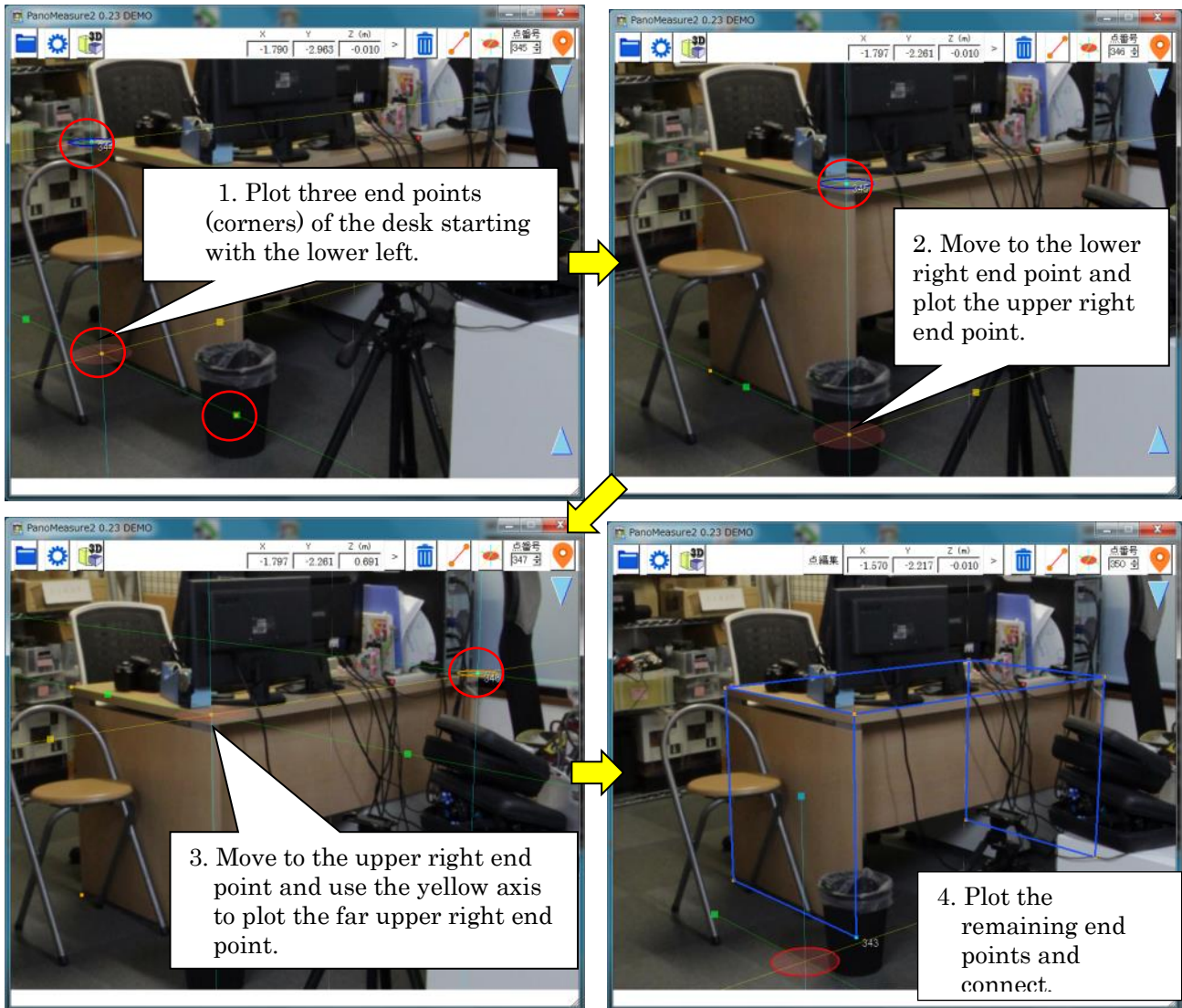

5.6. Drawing by Inputting Known Dimensions

With standardized products, such as this office desk, you often know the dimensions without measuring. If you know the measurements, you can draw the desk with this software by simply entering the dimensions of the desk in the boxes.

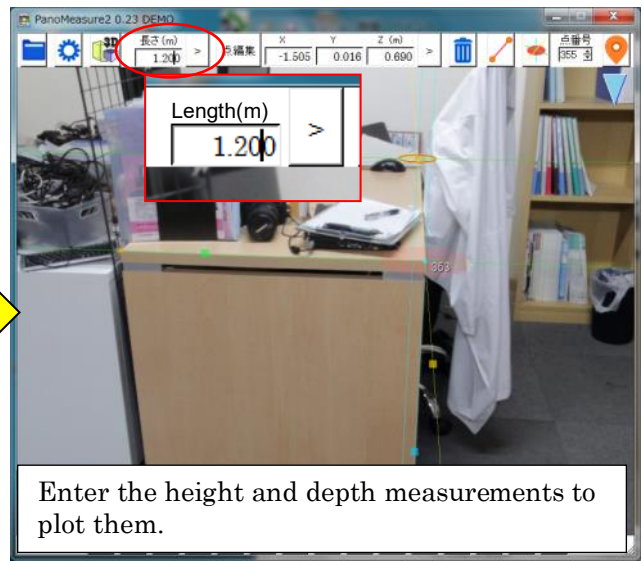
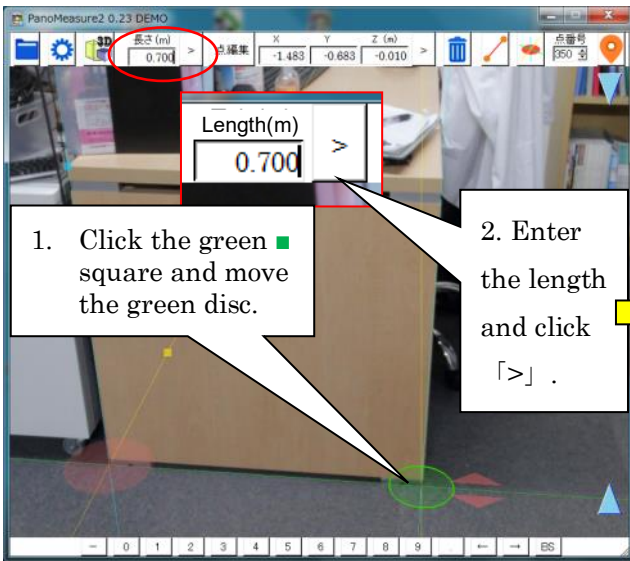

5.7. Adjusting Depth Using Known Dimensions

If the floor surface is not flat or is unclear, you cannot know the height (Z coordinate) of the VTM and cannot measure. However, as explained above, if you wish to set the coordinates for a dimension identical to one that is known, adjust the depth of the VTM to the actual dimension. This will enable you to calculate the correct depth and height.

In the example above, as $Z = 0.000$ m, if you set the length of the VTM to the actual 0.700 m of the desk length, a subtle shift will occur as shown in the figure below.

This shift occurs because the floor is slightly tilted and the camera position is not exactly at floor level.

Drag the  icon at the right of the screen up and down, adjusting it until the photo and the VTM match exactly. (The adjustment resulted in a measurement of $Z = -0.010$ mm) .

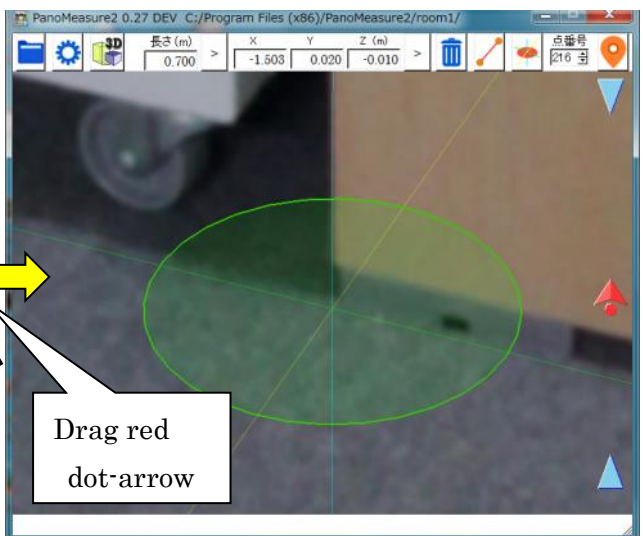
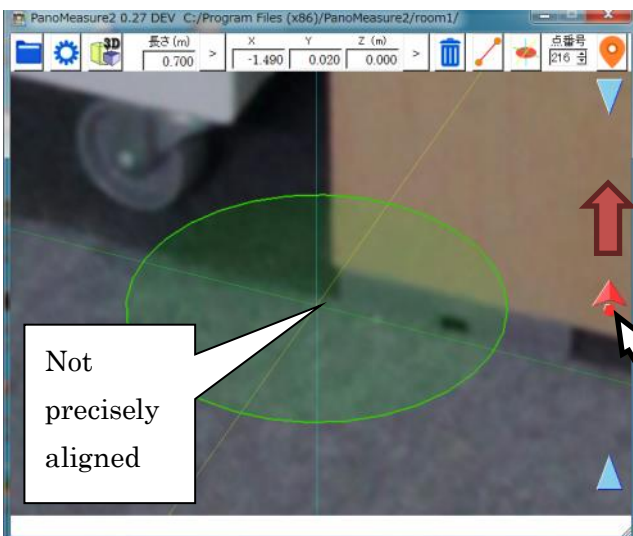

6. Converting Coordinates and Assembling Drawings

6.1. Dividing a space into Blocks and Producing Block Drawings

Dividing large spaces into blocks and creating separate block drawings (to reassemble later)

With omnidirectional cameras such as the Theta which capture an image of all directions in a single shot, resolution is low and picture quality is poor. Even with a Theta S, taking a single omnidirectional image and creating an accurate drawing requires that you limit the target radius to roughly 5 meters (depending on the level of accuracy you are willing to tolerate). So, to produce drawings for larger interior spaces, divide the space into blocks, take multiple omnidirectional shots from various points and create drawings for each block that will be assembled. To avoid blind spots caused by tight spaces, take shots from multiple viewpoints and combine them. This will enable you to create accurate, (mistake-free) final drawings.

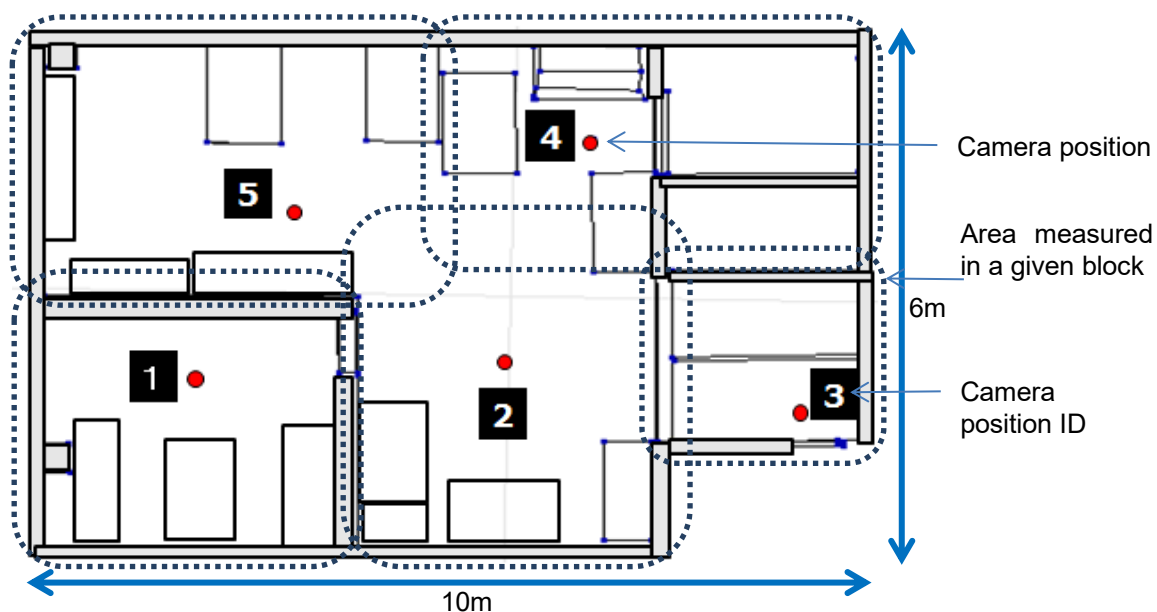

Example of a space divided into five blocks

6.2. The Need for Coordinate Conversion

The default positioning of the Panomeasure2 assumes the camera has been placed on the floor with the direction in front* of it being the X axis, the direction to the left being the Y axis and the direction above the camera being the Z axis. Changing the positioning of the camera, changes the coordinates and prevents the software from identifying the positions from which to assemble the exported drawings.

*the “front” of a Theta camera is the side opposite the shutter button

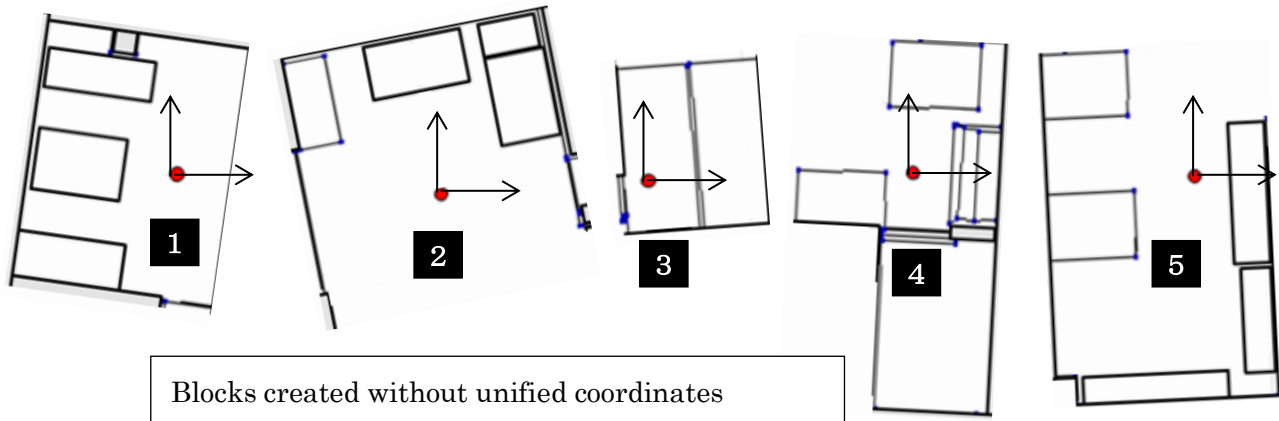

To avoid a jumble like the one above, it is necessary to convert the coordinates of all the blocks. Doing this enables drawings exported to CAD to be assembled even if they were created separately. Once coordinates are unified, simply layer the blocks as shown below.

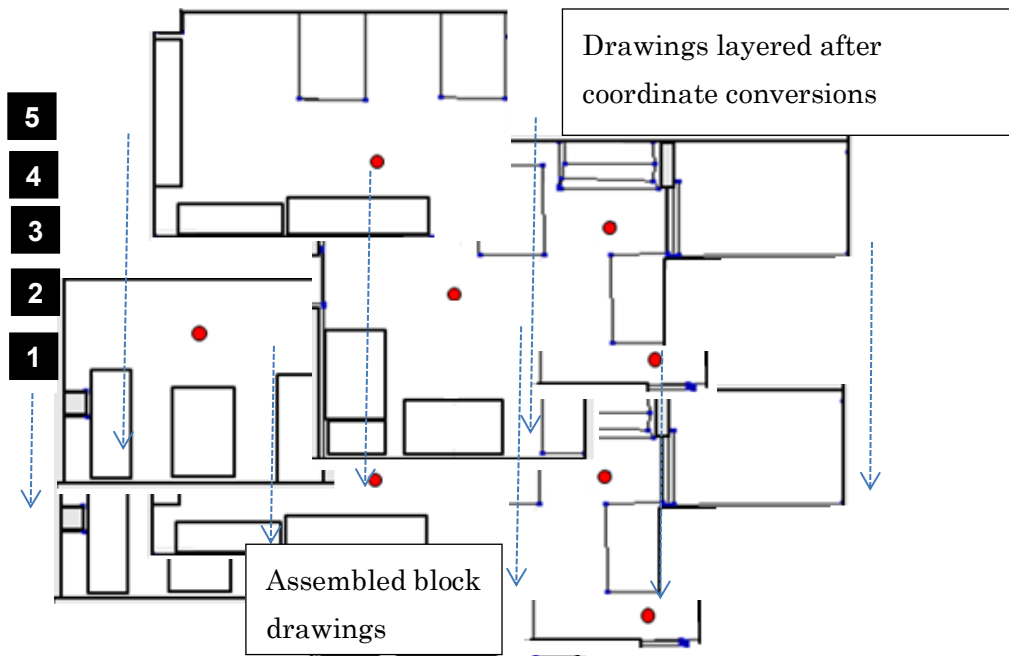

By importing drawings from images taken from adjacent positions, you can also efficiently create connected drawings without overlapping or duplicate plotting.

6.3. How to Convert Coordinates

The two steps of coordinate conversion are 1) to align the coordinate axes and 2) to move the drawings so that they have the same origin coordinates. By rotating the axes of 1), 2) can be achieved by specifying the coordinates of the center position of the VTM. This is explained further in the example below.

6.3.1. Specifying Origin Coordinates

Select “coordinate conversion” from the tool menu. A coordinate conversion window will open.

Following the procedure prompts will enable you to convert the coordinates.

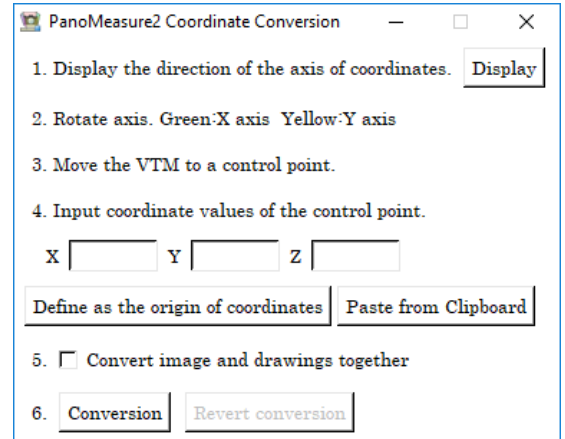
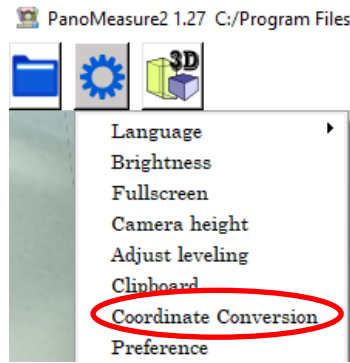

6.3.1.1. Using Coordinates to Unify Axis Arrow Direction

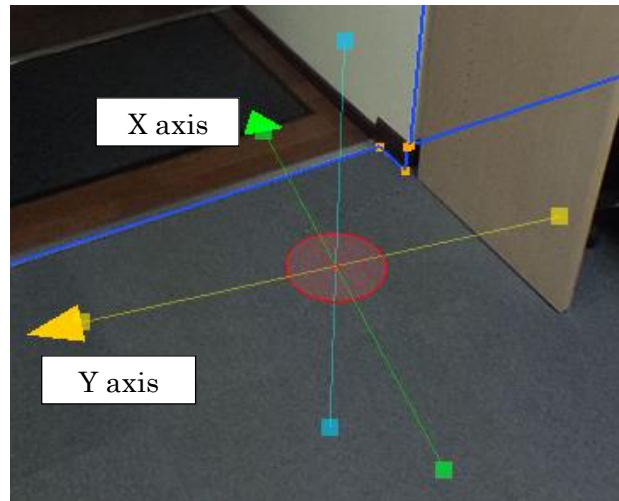
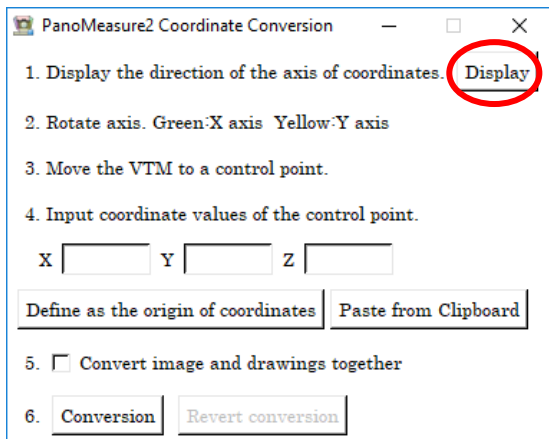

6.3.1.2. Rotating the Coordinate Axis. (the X axis is green, and the Y, yellow)

To correctly position the coordinate axis direction, it is helpful to select a long line you have already drawn and align it with that.

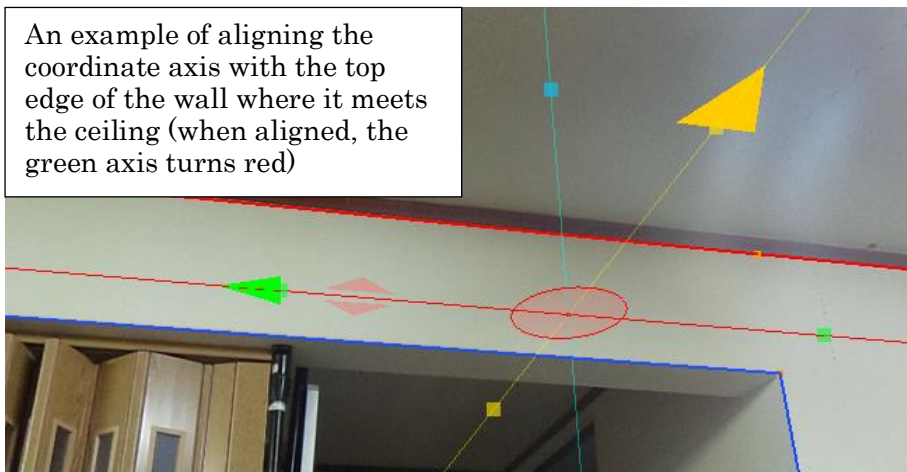

6.3.1.3. Moving the VTM to the Reference Point

Move the Virtual Tape Measure to the reference point. Select any point along a mutual border between two blocks.

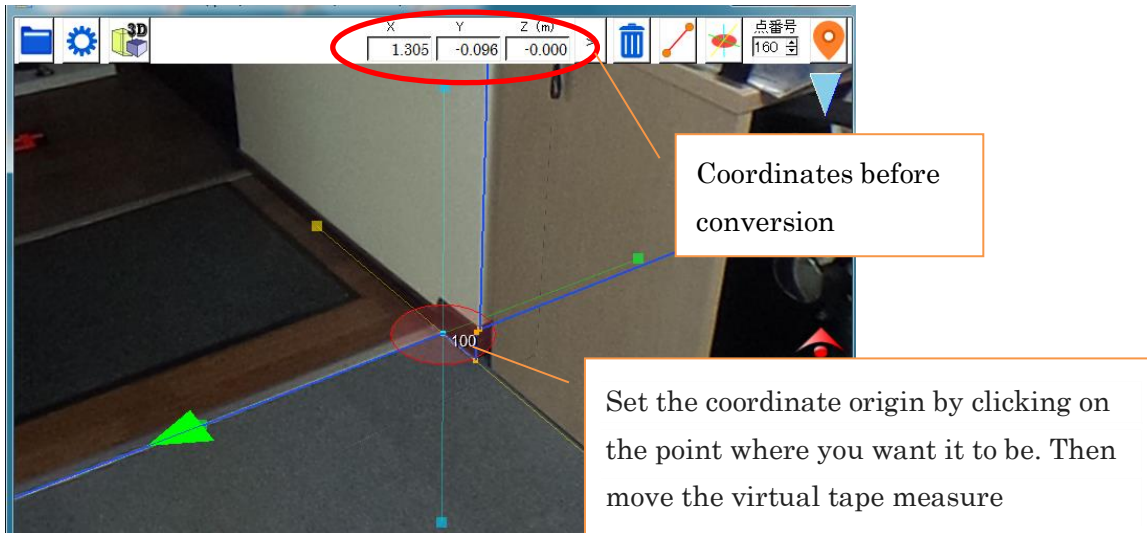

6.3.1.4. Inputting Reference Point Coordinates

Input the coordinates for the points you selected as reference points. When you click on “set the coordinate origin” to convert the coordinate origin to a reference point, the coordinate value will be (0.0 0.0 0.0).

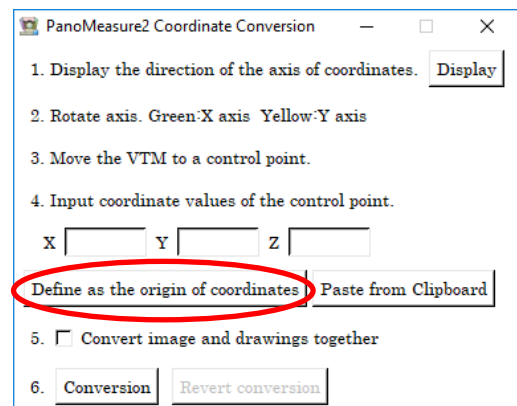

6.3.1.5. Clicking on “Convert.”

Click “convert.” The conversion will take place immediately. Your specified reference point coordinates, (1.305-0.096, 0.000 in the example photo above) will change to (0.0 0.0 0.0).

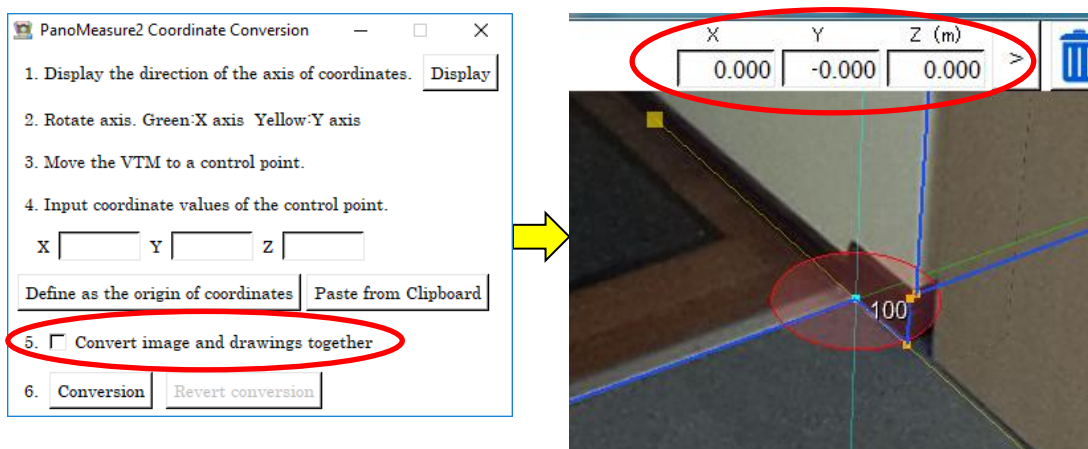

6.3.1.6. Clicking on “Undo Coordinate Conversion” to Try Again

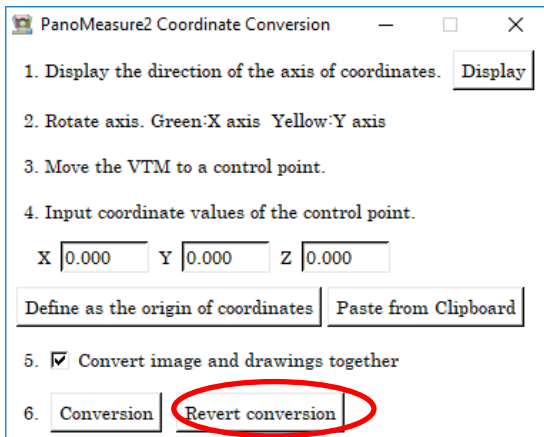

6.3.2. Using the Clipboard to Specify the Reference Point Coordinates

Specifying the coordinate reference point is relatively straightforward, but the coordinate reference point origin may not be clearly visible in every block image. Also, if the coordinate origin is far from the viewing point, it may produce a large error in the initial coordinates, resulting in large deviations overall. To avoid this, a reference point near the boundary line of the adjacent block should be used when converting the coordinates.

Although this does not pertain to steps 6.3.1.1 through 5 above, you can use the clipboard to record the coordinates before converting the coordinates. The clipboard enables you to copy and paste the coordinates when moving between/among tasks.

Step 1. Plot a clearly defined reference point at the border of two blocks.

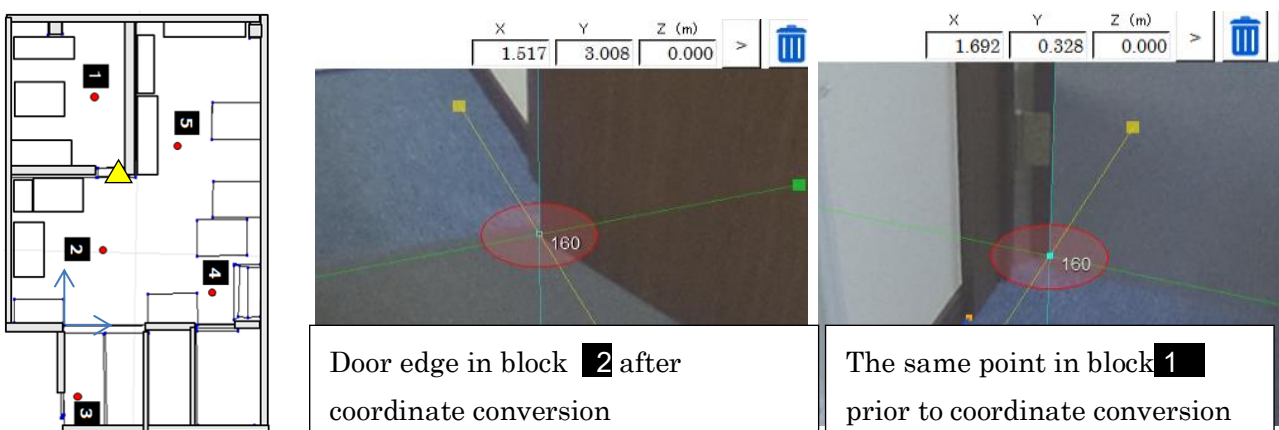

Step 2. Open the coordinate conversion screen.

Click on the reference point you just selected. Click on “edit point” in the toolbar. In the edit point window that appears, click on ”copy to clipboard.”

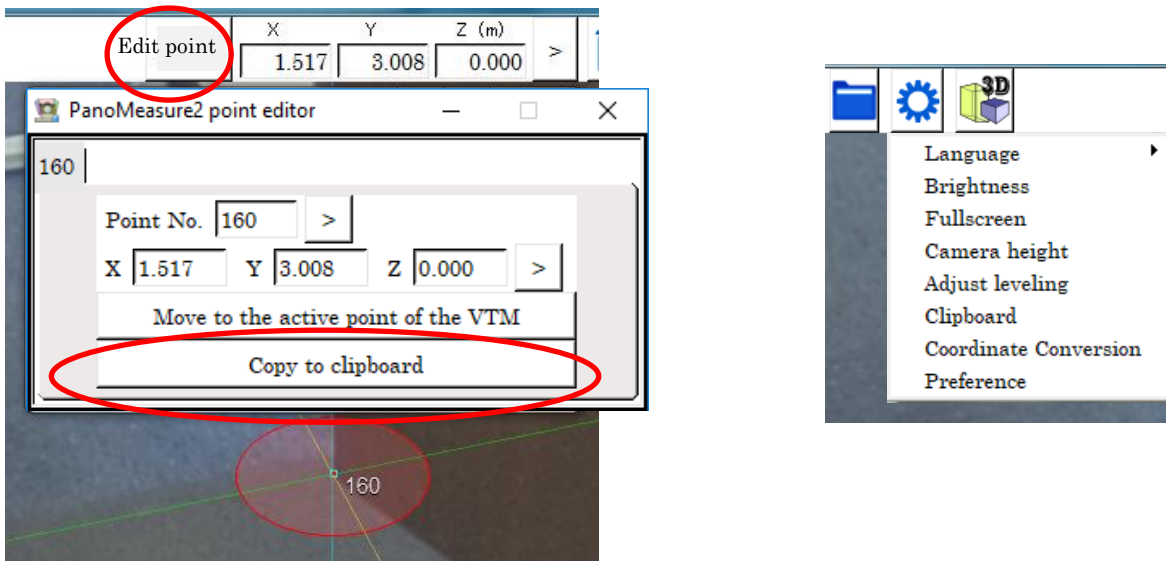

Step 3. Select “clipboard” from the tool menu

Step 4. Select the images you wish to copy from the next list that appears.

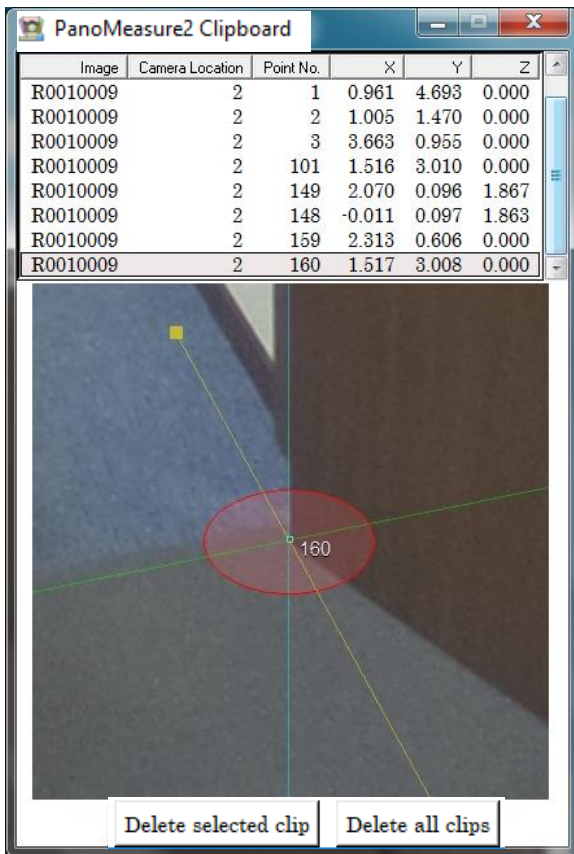

This completes coordinate conversion preparation. Keep this window open until coordinate conversion has been completed.

Refer to “Specifying Origin Coordinates” (in section 6.3.1.1 above) for the steps for coordinate conversion. (Follow 6.3.1.1 through 6.3.1.3.)

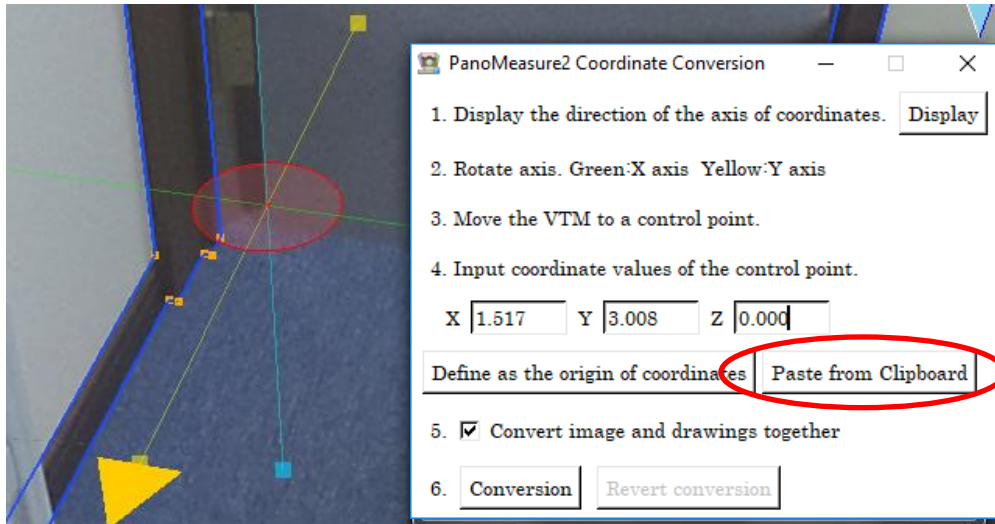

After Step 6.3.1.3, select “paste from clipboard” and enter the reference point coordinates.

6.4. Loading the Drawing Data After Coordinate Conversion

There are two ways to load drawing data. The “load after drawing each block” process and the “load after drawing all blocks” process. If you have unified all the image origin coordinates beforehand, you can now assemble contiguous drawings from the space you divided into blocks. Once you have completed a drawing for one block, open the adjacent image and load the data for the next block to connect them. Connecting data from each subsequent image will enable you to add additional blocks and complete assembled drawings of large areas.

If, on the other hand, you have already drawn all the blocks for one space, after converting and unifying the drawing coordinates, load and save the data for each image’s drawing. In this way, you can produce an assembled drawing of a large area without using CAD.

In the image below, room 1 data has been loaded onto a room 2 image after conversion and unification of the coordinates. The five steps for unification of the two room blocks are given below.

Step 1: Open the demonstration screen image 1, using the method from 6.3.1.1 Specify the coordinate origin points and the coordinate direction and convert the coordinates.

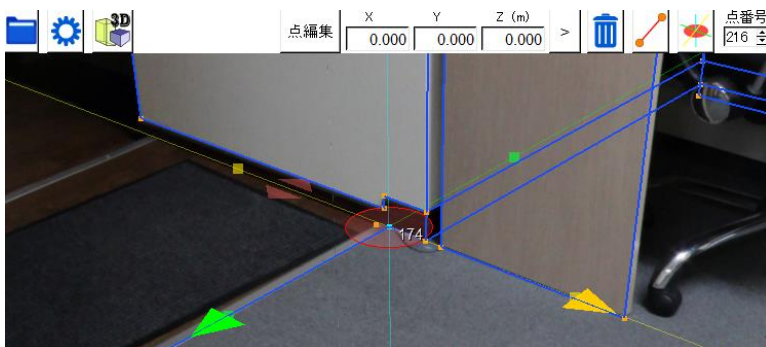

Step 2: Copy an image showing both room 1 and room 2 to the clipboard as discussed in 6.3.2.

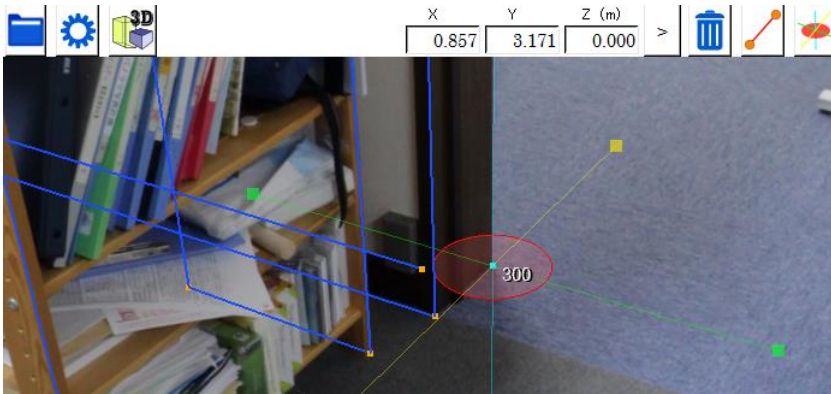

Step 3: Open the demonstration screen for room 2 and convert the coordinates as explained in 6.3.2.

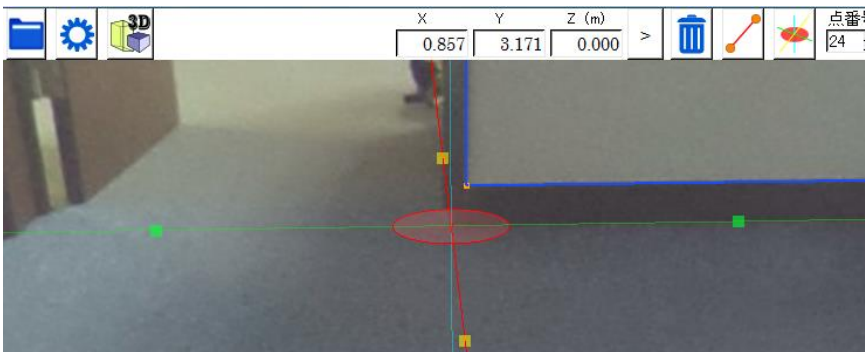

Step 4: Load autosave. pmz in room 1.

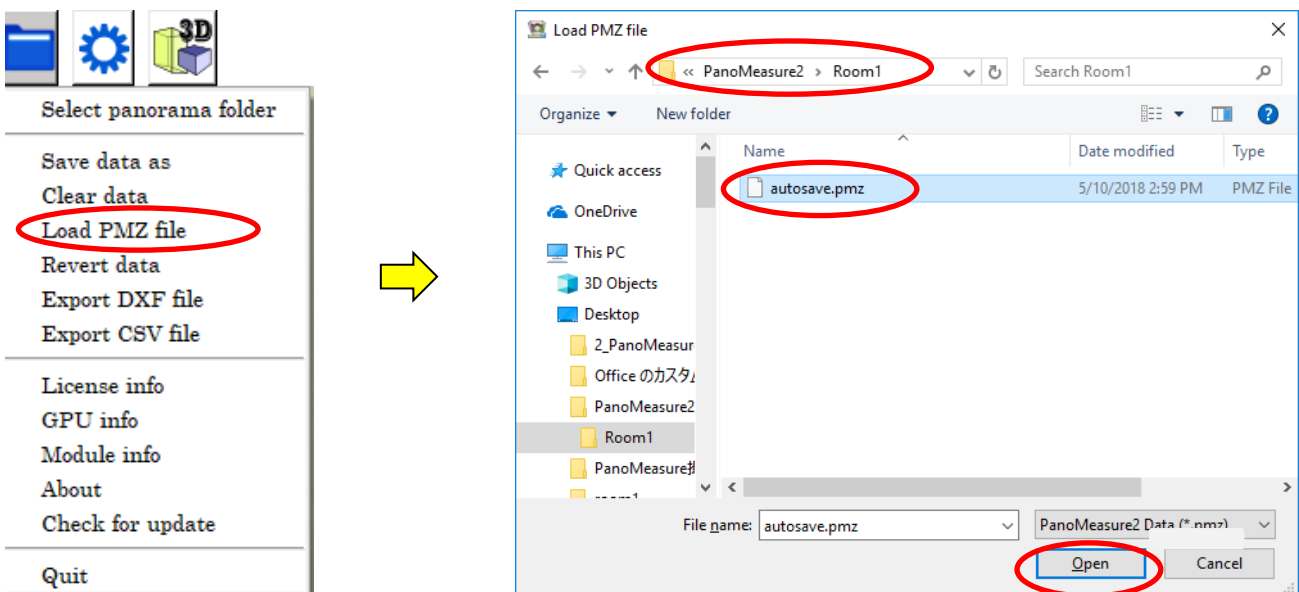

If you are not satisfied, try again by clicking on “data recovery” to return to the step before loading.

Step 5: Check your work in “3D View.”

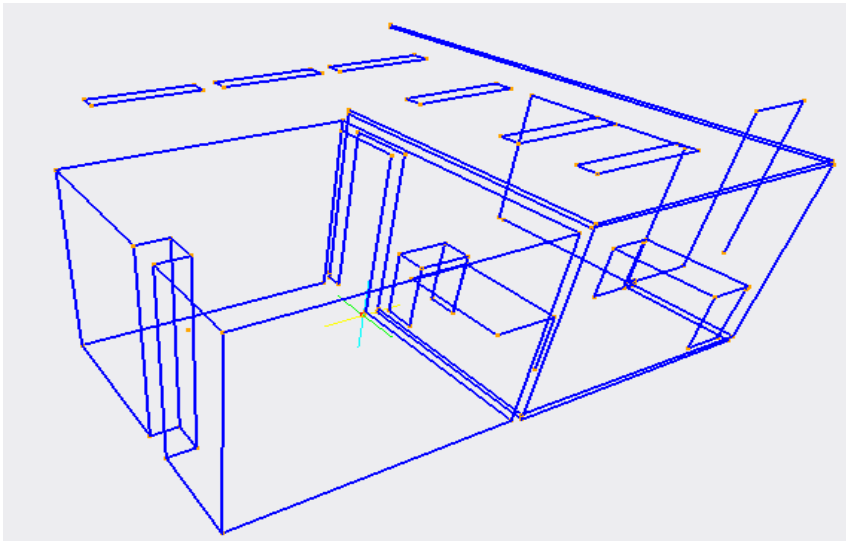

6.5. Moving the Vantage Point

You can easily change your vantage point from one image to another when two images created during the same project have consistently converted coordinates.

After coordinate conversion, look directly under the camera and you should see a red dot has appeared in the yellow circle. This yellow circle indicates the vantage point.



After this red dot has appeared, you can jump from room to room. When you look in the direction of the next room (where coordinate conversion has been completed), you should see the yellow circle of that room’s vantage point. Clicking twice on that yellow circle will move your vantage point there.

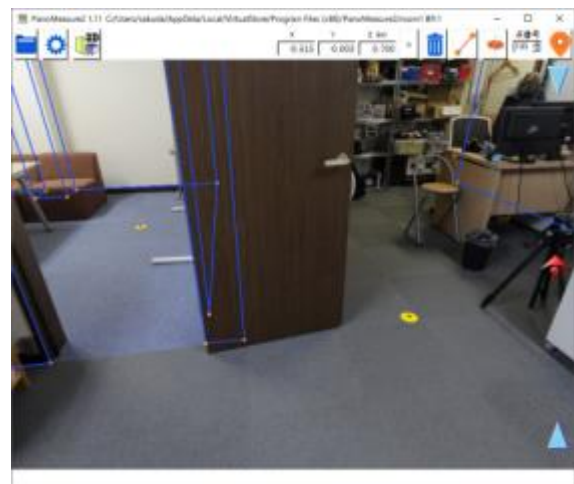

7. Other Functions

7.1. Saving Data under a New Name, and Loading, Deleting and Recovering Data

In post-revision 1.05 versions of PanoMeasure2, drawing data is saved to a file in autosave pmz in the image folder. This is a database file and cannot be edited with text editor. Files are automatically saved as named.

The functions available are those shown in the pull-down file menu at right. Other functions available from the file menu are as shown.

If you accidentally delete or load data, you can use **“revert data” to separate assembled blocks or recover deleted data.** Note that this is not an “undo” editing function that takes you one step back in a drawing. To correct an edit, use the undo function that will become available in an upcoming version.

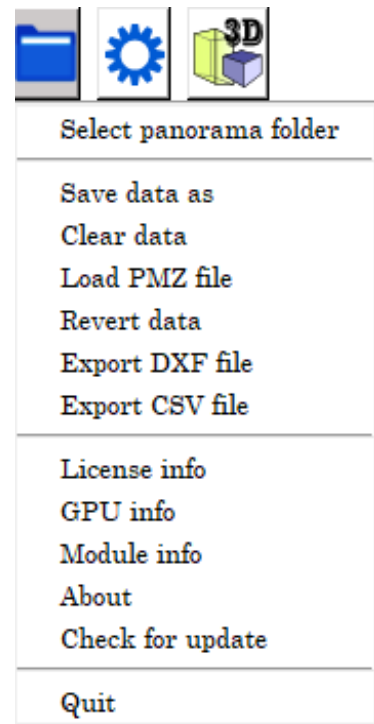

7.2. Exporting Data

By selecting “export DXF format data” you can export DXF format drawing data to AutoCAD and other software. In addition, by selecting “export CSV format data” you can export data calculated on EXCEL spreadsheet software.

7.3. License Information

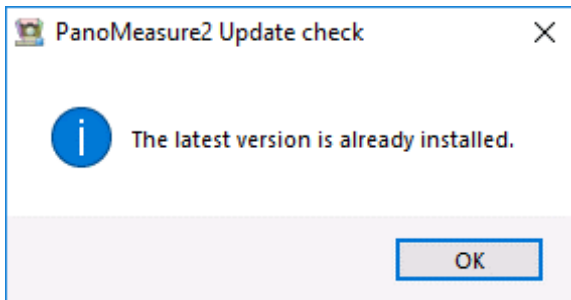

The prompt above will appear if you are using the standard PanoMeasure2 software and with a valid license. If you have a temporary license the prompt at right will appear.

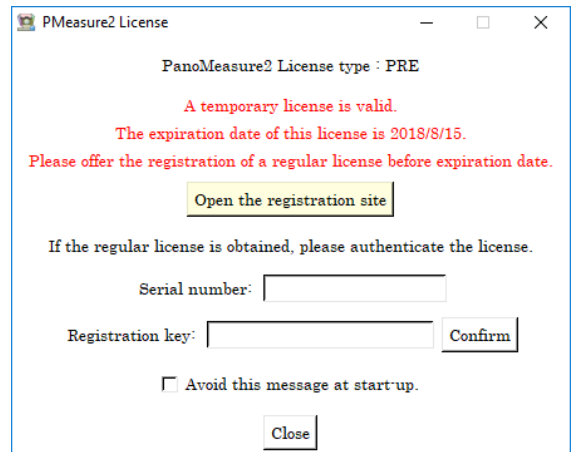

7.4. GPU Information

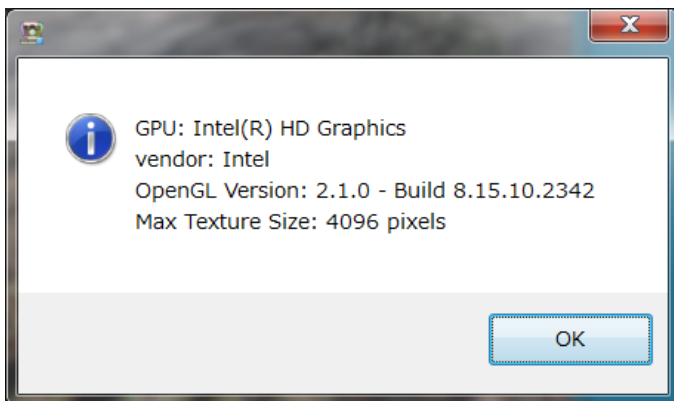

Selecting GPU information will display information on your computer graphics board (GPU). If the version you are using is older than the 2.1 OpenGL version shown above, images will not display properly. Also note that images will not display if the cubic divisions (pixels) are less than the maximum texture size of the image. The cubic divisions of an image from a Theta omnidirectional camera are 1141 x 1141 pixels and those from a Theta S omnidirectional camera are 1712 x 1712. Some cubic divisions from PTGui can be over 2000 pixels.

7.5. Software Information

Selecting “software information” will open the dialog box below.

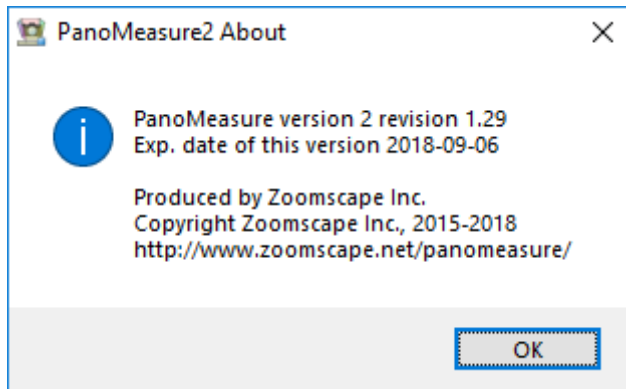

7.6. Confirming Newest Software Version Updates

When you click on “check for update” a message box will appear telling you whether your software is the latest version or not.

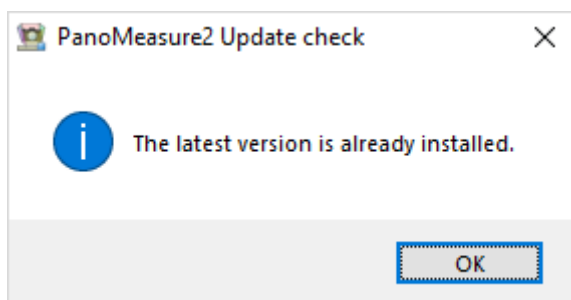

8. Tool menu

8.1. Changing the Display Language

Select “language” from the tool menu. Click on “English” to display content in English. Content will continue to display in English until you change the language to Japanese. To switch to Japanese, select it from the tool menu.

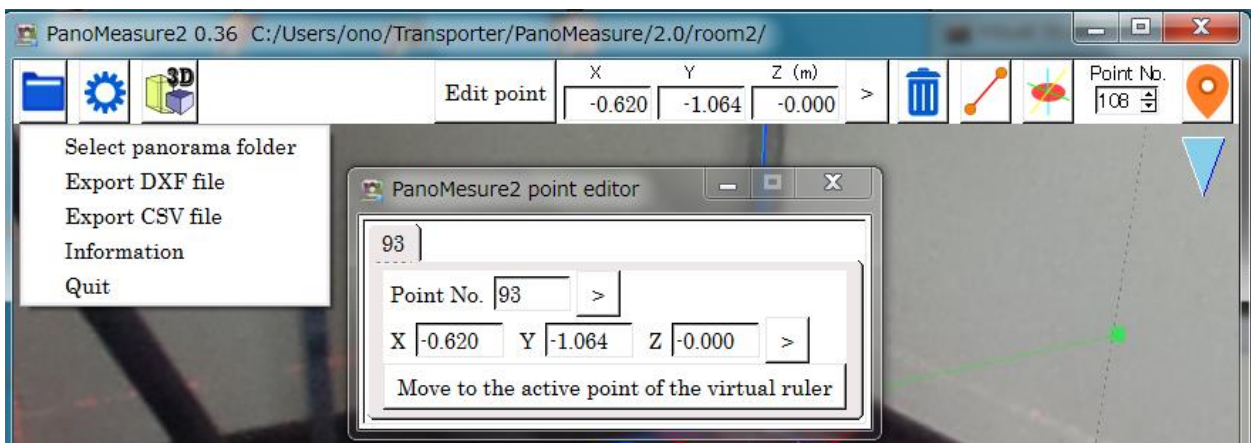

8.2. Brightness Control

Selecting “brightness control” will open a brightness slide bar. Sliding the bar to the left or right will dim or brighten the whole screen.

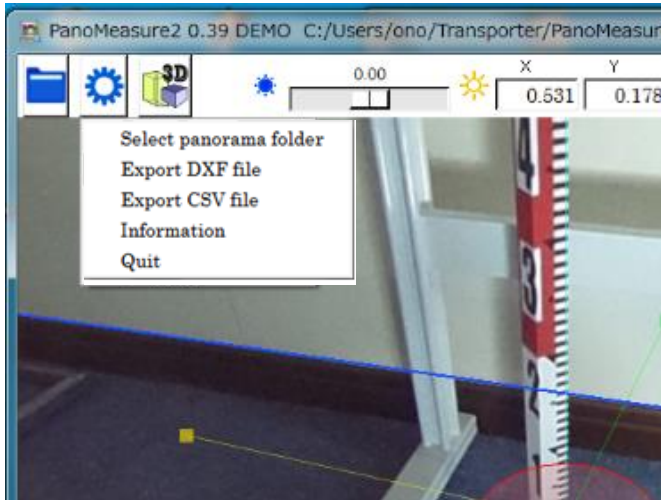

8.3. Switching to Full Screen

Selecting “full screen” from the toolbar will enlarge the screen to maximum size. Selecting it again or hitting the Esc (escape) key will return it to a partial screen.

8.4. Changing the Window Size

The PanoMeasure2 software displays all the standard Windows functions such as: window size, maximum screen size, screen rotation. It does not respond when it is in tablet mode.

8.5. Settings (Changing Units of Length, Adjusting the Maximum Viewing Angle)

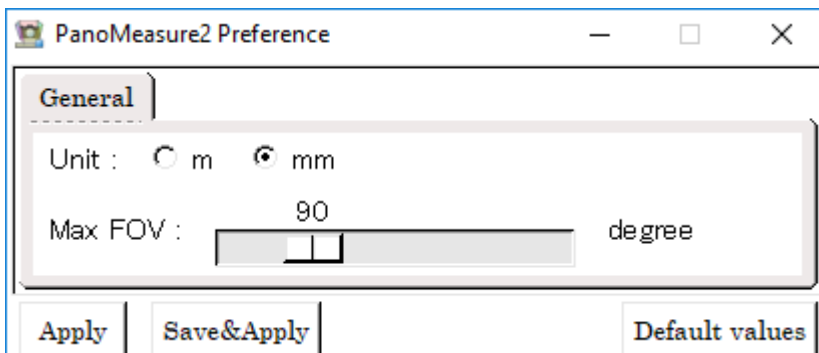

- Changing Units of Length: Panomeasure2 units can be converted to meter and millimeter units.

Exported data will also use the units you selected in “Settings.” Select the units best suited your image.

- Adjusting the Maximum Viewing Angle: Adjusting the amount of a room visible on the screen. (the view angle)

9. Operating Requirements

■ Compatible Operating Systems

PanoMeasure2 is operational with Windows 7, 8, 8.1 and 10. * It will also function on Windows XP or Vista, but we are unable to guarantee it will be trouble free.

*If you are using an old CPU/GPU, Windows 7 and 8 should operate normally, but Windows 10 may not. Windows 10 does not allow drivers without signatures or old signatures. If the manufacturer does not supply a Windows 10 compatible driver, the generic driver from Microsoft will load and this will limit the functions typically available in the graphics chip. For example, for Core2Du generation computers equipped with the chip sets, Intel G21/Q43/Q45/G43/G45, Intel has not provided a Windows 10 driver, so the open GL 2.1 or equivalent functions typically available in an internal GPU cannot be used.

If you are using a computer with a pre-Windows-10 driver do not upgrade to Windows 10.

■ PanoramaMeasure2 Compatible Computers

Computers and tablets with GPU that support Open GL 2.1 and later versions and have 50MB or more storage capacity available.

■ Supported Panorama Images

- Omnidirectional images taken with a Ricoh Theta or Ricoh Theta S/SC/V (provided the PanoMeasure2 Theta Cube is used to convert equidistant cylindrical projection image data to PanoMeasure2 compatible data).
- Horizontally corrected PTGui or Hugin cubic panorama images (Images must be converted to cubic panorama image format.) The maximum cubic panorama size is 3000 × 3000 pixels.

For more information on PanoMeasure2 contact us at:

Zoomscape Co., Ltd.
413 4F Korabo-shiga21, 2-1 Uchidehama Otsu, Shiga 520-0806 JAPAN
TEL 81-77-514-8191 FAX : 81-77-514-8192
URL <https://www.zoomscape.net> E-mail panomeasure@zoomscape.net